

RULES ON SIGNS

Light always travels from Left to Right

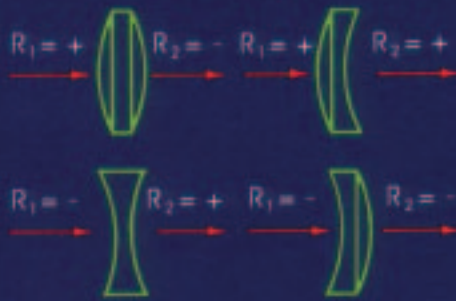

OBJECT - IMAGE RELATIONSHIP

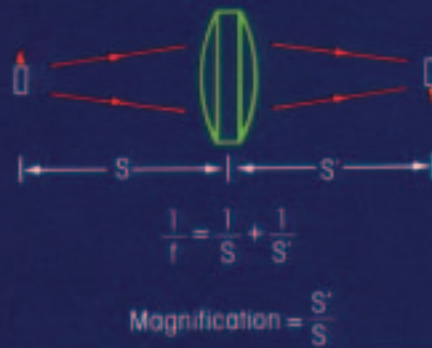

TWO THIN LENSES

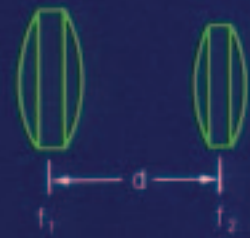

Resultant Focal Length $f_r = \frac{f_1 f_2}{f_1 + f_2 - d}$

PROPER ORIENTATION FOR BEST IMAGING

PLANO - CONVEX CASE

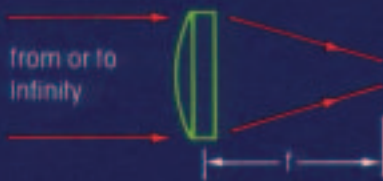

UNEQUAL BICONVEX CASE

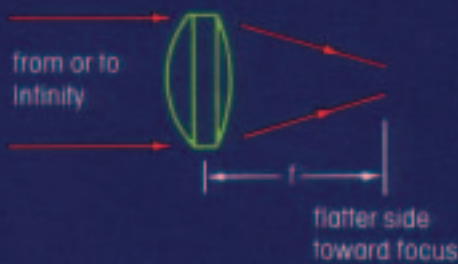

EQUICONVEX CASE



Optics for Research



PRECISION OPTICAL COMPONENTS

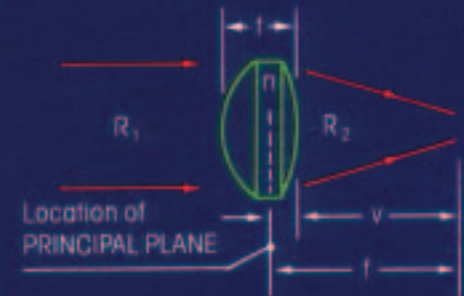
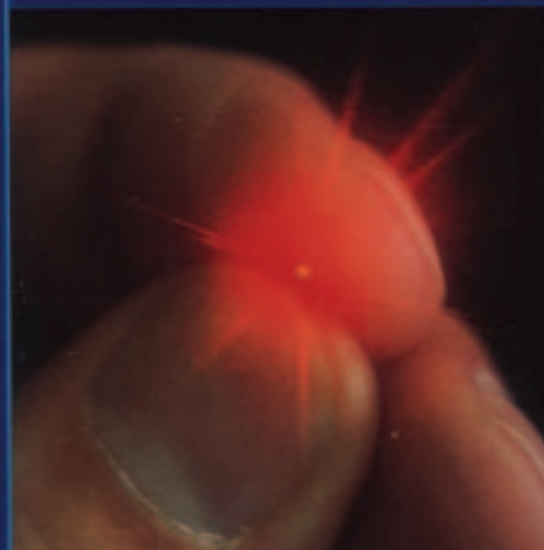

1. $\frac{1}{f} = (n-1) \left[\frac{1}{R_1} - \frac{1}{R_2} + \frac{t(n-1)}{nR_1R_2} \right]$

or if $t \ll$ Diameter (1 : 6 or more)

1a. $\frac{1}{f} = (n-1) \left[\frac{1}{R_1} - \frac{1}{R_2} \right]$

2. $v = f \left[1 - \frac{t(n-1)}{nR_1} \right]$

3. $p = - \frac{ft(n-1)}{nR_1}$

4. $f = \frac{vn+t}{n}$

SAGITTAL HEIGHT OF SPHERICAL SURFACE

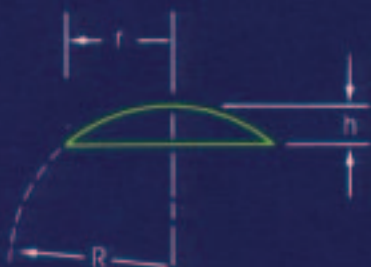

$h = R - (R^2 - f^2)^{1/2}$
 $= R \left[1 - \cos \left(\sin^{-1} \frac{f}{R} \right) \right]$

FOCUSING A LASER BEAM TO MINIMUM SPOT



ASSUMPTIONS

- a. light is collimated
- b. single lens: OFR BestForm type

1. Determine OPTIMUM FOCAL LENGTH, f_0

$f_0 = C(d^4/\lambda)^{1/3}$ λ (mm)

where C = 0.375 for n = 1.5	
= 0.24	= 2.4
= 0.19	= 4.0

2. Determine BLUR CIRCLE Size

a. using OPTIMUM FOCAL LENGTH, Blur Circle is either of the following:
- or -

b. if not OPTIMUM FOCAL LENGTH, Blur Circle is the LARGER of the following:

$\frac{Kd^3}{f^2}$ or $\frac{1.27\lambda f}{d}$ λ (mm)

where K = 0.067 for n = 1.5	
= 0.018	= 2.4
= 0.0087	= 4.0

REQUEST DESIGN MEMO NO. 1

- A** Analyzer, Polarization
 - Apodizer
 - Attenuators, Fiber-Optic
 - Attenuators, Fiber-Optic, Variable
- B** Beamsplitters
 - Beamsplitters, Fiber-Optic
 - Beam Expanders, Laser
 - Birefringent Filters
- C** Cables, Fiber-Optic
 - Cables, Fiber-Optic, Delivery
 - Circulators, Fiber-Optic
 - Collimators, Laser
 - Collimators, Pigtailed
 - Collimators, Snap-On
 - Combiners, Fiber-Optic
 - Compensator, Soleil-Babinet
 - Conditions, Terms & Coupling Lenses, Fiber-Optic
- D** Delay Lines, FiberBench
 - Delivery Cables, Fiber-Optic
 - Depolarizers
 - DetectorPorts
- E** Etalons, Solid
- F** Faraday Rotator Mirrors, pigtailed
 - Faraday Rotators, Fiber-Optic
 - Fiber to Fiber Isolators
 - Fiber to Fiber Systems
 - Fiber Isolators
 - FiberBench
 - FiberBench Delay Lines
 - FiberBench Kits
 - FiberBench Retrace Systems
 - FiberBench Splitters, Variable
 - FiberCables
 - Fiber-Optic Attenuators
 - Fiber-Optic Attenuators, Variable
 - Fiber-Optic Beamsplitters
 - Fiber-Optic Cables
 - Fiber-Optic Circulators
 - Fiber-Optic Collimators
 - Fiber-Optic Coupling Lenses
 - Fiber-Optic Delivery Cables
 - Fiber-Optic Faraday Rotators
 - Fiber-Optic Focusers
 - Fiber-Optic Isolators
 - Fiber-Optic Polarization Components
 - Fiber-Optic Polarization Controller
 - Fiber-Optic Polarization Rotators
 - Fiber-Optic Polarizers
 - Fiber-Optic Splitters, Variable
 - Fiber-Optic Splitters/Combiners
 - FiberPorts
 - Fiberports, mounting
 - Fiberport, interchangeable lenses
 - Filters, Birefringent
 - Filters, Neutral Density
 - Focusers, Fiber-Optic
 - Focusing Objectives, UV
 - Focusing Objectives, YAG
 - Fresnel Rhomb
- I** Isolators
 - Isolators, Fiber-Optic
- J**
- K** Kits, FiberBench
- L** Laser Beam Expanders
 - Laser Collimators
 - LaserPorts
 - Laser to Fiber Isolators
 - Lenses
 - Lenses, Achromatic
 - Lenses, Coupling, Fiber-Optic
- M** Microscope Objectives for VIS-NIR
 - Microspot Objectives for UV, YAG
 - MirrorPorts
 - Mirrors, Dielectric
 - Mirrors, Metallic
 - Mirrors, Faraday Rotator
 - Mounting the Fiberport
- N** Neutral Density Filters
- O** Objectives, Microscope
 - Objectives, Reflective
 - Optical Isolators
 - Optical Power Delivery Cables
- P** Pellin Broca prism
 - PM fibers
 - Polarization Analyzer
 - Polarization Components, Fiber-Optic
 - Polarization Controller, Fiber-Optic
 - Polarization Dependent Isolators
 - Polarization Independent Isolators
 - Polarization Measurements
 - Polarization Mode Dispenser
 - Polarization Reference Standards
 - Polarization Rotators
 - Polarization Rotators, Fiber-Optic
 - Polarizers
 - Polarizers, Fiber-Optic
 - Polarizing Beamsplitter
 - Prisms
 - Prisms, Coupling
 - Purchase Terms
- R** Retarder, Variable
 - Retarder, Multiple
 - Retarders, Zero Order
 - Retarders, Fiber-Optic
 - Rotators, Polarization
 - Rotators, Polarization, Fiber-Optic
- S** SM Fibers
 - Snap-On Collimators
 - Soleil-Babinet Compensator
 - Solid Etalons
 - Splitters, Fiber-Optic, Variable
 - Splitters/Combiners, Fiber-Optic
 - Standards, Polarization Reference
- T** Terms & Conditions
 - Tweakers
- V** Variable Fiber-Optic Attenuators
 - Variable Retarder
 - Variable Delay Lines
- W** Windows

Contents

PRECISION OPTICAL COMPONENTS

<u>Part</u>	<u>Page No.</u>
ABS	OC-31
ABSU	OC-31
ABSV	OC-31
AD	OC-30
ADB	OC-31
ADBU	OC-31
ADBV	OC-31
ADG	OC-32
ADT	OC-32
ADU	OC-30
ADV	OC-30
AT	OC-32
DPU	OC-25
GC	OC-11
EL	OC-10
ELQ	OC-11
ELU	OC-10
FD	OC-33
IE	OC-35
LC	OC-8
LCQ	OC-8
LCU	OC-8
LCV	OC-8
LL	OC-5,9
LLA	OC-7
LLO	OC-9
LLQ	OC-6
LLS	OC-7
LLU	OC-3,4
LLV	OC-3
LMO	OC-9
M	OC-13
MH	OC-13
MI	OC-13
MR	OC-13
MU	OC-13
MS	OC-17
MT	OC-17
MY	OC-16

MX	OC-16
MXY	OC-15
PB	OC-24
PE	OC-23
PEH	OC-23
PHB	OC-25
PM	OC-24
PQ	OC-23
PSCL	OC-20, 24
PSP	OC-21
PSU	OC-22
PSV	OC-22
PT	OC-25
PUM	OC-24
PUR	OC-22
PVR	OC-22
RA	OC-28
RC	OC-29
RM	OC-26
RMA	OC-26
RZ	OC-27
SB	OC-29
SCL	OC-20
SU	OC-19
W	OC-34
WQ	OC-34
WU	OC-34
WV	OC-34

MicroSpot OBJECTIVES

<u>Part</u>	<u>Page No.</u>
LMH	MS-5
LMU	MS-3

AIR-PATH ISOLATORS

<u>Part</u>	<u>Page No.</u>
IO-(244-505)	IO-9
IO-(505-700)	IO-10
IO-(700-925)	IO-11
IO-(925-1100)	IO-13
IO-(1260-1650)	IO-14
IO-1950-2200)	IO-14

FIBER-OPTIC PRODUCTS

<u>Part</u>	<u>Page No.</u>
ACB	FO-11
CFC	FO-45,46
CFM	FO-47
CFS	FO-47
CSMA	FO-46
FB	FO-4
FB-PAM	FO-34
FCB	FO-11
FCM	FO-10,43
FCP	FO-9,42
FCS	FO-9,42
FDB	FO-15
FFBx	FO-19
FLBx	FO-20
FMB	FO-8
FMBS	FO-25
FS	FO-47
FT	FO-4
FTBx	FO-20
HCB	FO-11
HCF	FO-45,46
HEF	FO-46
HW	FO-12
IO-F	FO-50
IO-FFB	FO-21
IO-FLB	FO-22
IO-G	FO-51
IO-H	FO-50
IO-J	FO-51
IO-PAF	FO-51
IOB	FO-23
LPR	FO-28
LL	FO-16,41
LLO	FO-16,41
MFI	FO-54
MFI-FMB	FO-25

MS	FO-13
OC	FO-52
OCM	FO-52
OCT	FO-52
PAD	FO-34
PAF	FO-6,37,38
PAL	FO-7,40
PBB	FO-14
PC	FO-30
PCB	FO-14
PFC	FO-49
PFP	FO-29
PFS	FO-49
PFSV	FO-23
POA	FO-6,16
PSO	FO-29
PSP	FO-13
PTE	FO-40
RCB	FO-11
RMAB	FO-15
RZB	FO-15
SOP	FO-28,34
VA	FO-26
VDL	FO-24



Precision Optical Components

Optics for Research
 Box 82
 Caldwell, New Jersey 07006
 (973) 228-4480
 FAX: (973) 228-0915
 www.ofr.com
 info@ofr.com

DESIGN AND MANUFACTURING

Optical Engineering/Design
 Manufacturing of Optical Components
 Electro/Magneto-Optic Devices

CONTENTS	PAGES
Lens Design Notes	OC-2
Laser Lenses	OC-(3-6)
Air-Spaced Doublet Lenses	OC-7
Cylindrical Lenses	OC-8
Microscope Objectives	OC-9
Laser Beam Expanders	OC-10, 11
Apodizer (Flat-Top)	OC-11
Mirrors, Front-Surface	OC-12, 13
Dielectric Coatings	OC-14
Laser Reflectors, Beamsplitters	OC-(15-20)
Beamsplitters	OC-18, 19
Polarization-State-Preserving Beamsplitters	OC-21
Polarizers	OC-(22-25)
Depolarizers	OC-25
Laser Retarders	OC-26, 27
Broadband Retarders	OC-28
Variable Retarders	OC-29
Birefringent Filters	OC-29
Prisms	OC-30, 31
Coupling Prisms	OC-32
Neutral Density Filters	OC-33
Windows	OC-34
Solid Etalons	OC-35

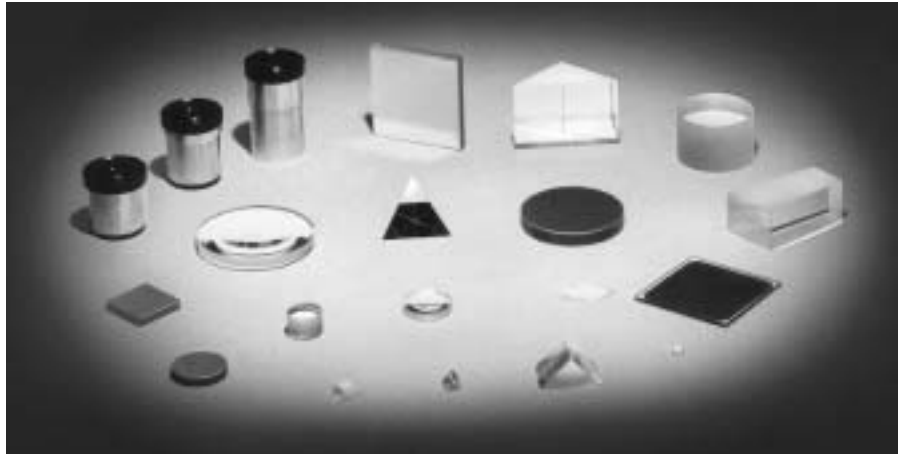

Optical Engineering and Design Services

OFR is frequently called upon for the solution of optical component or system design problems, ray tracing or design, or problems in optical physics.

We work with the most advanced computer design programs, and we maintain the goal of a design which is economical to manufacture yet meets performance specifications. We invite solicitations requiring design of:

- Telescope Objective Lenses & systems
- Copy lenses
- Scanning optics and systems
- Laser printing lenses
- Medical optics and systems
- Projection optics
- Spectrometer optics
- Analytical optics
- Fiber optic devices and systems

PRECISION OPTICAL COMPONENTS

Part	Page No.	Part	Page No.	Part	Page No.	Part	Page No.	Part	Page No.
ABS	OC-31	ELQ	OC-11	LMO	OC-9	PM	OC-24	RMA	OC-26
ABSU	OC-31	ELU	OC-10	M	OC-13	PQ	OC-23	RZ	OC-27
ABSV	OC-31	FD	OC-33	MH	OC-13	PSCL	OC-20,24	SB	OC-29
AD	OC-30	IE	OC-35	MI	OC-13	PSP	OC-21	SCL	OC-20
ADB	OC-31	LC	OC-8	MR	OC-13	PSU	OC-22	SU	OC-19
ADBU	OC-31	LCQ	OC-8	MU	OC-13	PSV	OC-22	W	OC-34
ADBV	OC-31	LCU	OC-8	MS	OC-17	PT	OC-25	WQ	OC-34
ADG	OC-32	LCV	OC-8	MT	OC-17	PUM	OC-24	WU	OC-34
ADT	OC-32	LL	OC-5,9/FO-16	MY	OC-16	PUR	OC-22	WV	OC-34
ADU	OC-30	LLA	OC-7	MX	OC-16	PVR	OC-22		
ADV	OC-30	LLO	OC-9/FO-16	MXY	OC-15	RA	OC-28		
AT	OC-32	LLQ	OC-6	PB	OC-24	RC	OC-29		
DPU	OC-25	LLS	OC-7	PE	OC-23	RF	OC-28		
GC	OC-11	LLU	OC-3,4	PEH	OC-23	RFU	OC-28		
EL	OC-10	LLV	OC-3	PHB	OC-25	RM	OC-26		

Lens Design Notes

OFR manufactures the widest selection of standard, minimum aberration (Best Form) Laser Lenses available from any supplier. Combining quality and theory, these lenses will meet predicted performance within diffraction limit. We are concerned with the size of the focal spot (the "blur circle" diameter or Airy's Disc). The principles are described in any university-level physics text, namely the interplay between spherical aberration and diffraction.

Specifically, two phenomena occur -

- Refraction of a ray of light through a lens along with its resultant spherical aberration,
- Distribution of optical energy in the focal plane as caused by diffraction.

If there were no such thing as diffraction, then the focal spot would simply get smaller as the focal length increases (or conversely, as the aperture decreases) corresponding to decreasing spherical aberration.

There is a limit to how small the focal spot can become, even though spherical

aberration might approach zero. This is controlled by diffraction, which describes the distribution of energy at the focus. This is Airy's Disc, and is defined as the diameter of the central ring within which 84% of the energy is contained.

The two formulas relating to focal spot size are on the front cover of this catalog and below. Thus, the two factors controlling the size of the focal spot are described as:

- **Spherical aberration** The focal spot size, $b_s = 1.27\lambda f/d$ derives from the "resolving power" of an optical aperture focusing light from a distant star. The constant 1.27 corresponds to a monochromatic Gaussian beam. In the case of light from a distant star (white light of constant energy density cross-section), the constant is the familiar 2.44.
- **Diffraction** The focal spot size is $b_d = Kd^3/f^2$. K is a constant dependent upon the index of refraction. f is the focal length. d is the beam diameter.

See the formulas on the front cover of this section. These are approximations, intended to estimate quickly focal spot size.

We are concerned with the intersection of these two functions, from which we calculate our optimum focal length for any lens with respect to a beam of a specific diameter. Thus, $f_o = C(d^4/\lambda)^{1/2}$ (again, see formulas on front cover). Then, we calculate the two focal spot sizes, b_s and b_d . These will be equal when we use the lens at its "optimum focal length", f_o .

When the beam diameter exceeds the optimum aperture, or the focal length gets shorter, then diffraction is in control, and the focal spot grows rapidly by Kd^3/f^2 .

Conversely, when the beam diameter decreases, or the focal length increases, spherical aberration takes over, and the focal spot increases linearly by f/d .

OFR BestForm (minimum spherical aberration) Laser Lenses will perform to diffraction limit when used within the constraints described by these formulas.

Custom Lenses Manufacturing

At OFR we manufacture more lenses than any other type of component. Most of the lenses we manufacture are on a custom basis and in large quantities.

Therefore, not only do we offer our wide, standard line of off-the-shelf lenses, but we are especially skilled in rapid and precision manufacturing of lenses on a custom basis, in single and low quantities as well as in large quantities.

We manufacture lenses in all standard optical materials. Our largest lens is in the vicinity of 16 inches diameter.

Our current radius tooling and test plate values are also available on our website www.ofr.com. The designer is encouraged to base designs utilizing standard radii values and preferred glasses wherever possible; this will aid in reducing costs and delivery times.

Spherical Radius Tooling, millimeters

2.35	15.36	26.89	41.42	65.67	109.13	225.22	703.26
3.12	15.85	27.11	41.56	67.26	111.60	231.07	706.50
3.70	16.22	27.18	41.66	68.39	113.73	235.56	720.14
4.59	16.42	27.53	42.40	69.50	114.61	245.13	732.26
4.76	16.53	27.86	43.16	70.69	114.88	246.13	735.39
5.03	16.84	28.27	43.41	71.86	115.17	249.54	760.00
5.43	16.91	28.64	43.71	73.10	117.77	260.90	841.95
5.56	17.10	29.04	44.16	74.42	121.45	265.14	848.13
5.77	17.56	29.49	44.62	75.28	123.45	269.13	848.90
5.99	18.18	29.88	45.11	75.77	124.66	280.69	918.45
6.14	18.50	30.28	45.59	76.05	126.86	282.80	977.44
6.34	18.54	30.36	46.57	77.09	128.47	302.85	1061.04
6.45	18.80	30.85	46.71	78.60	129.30	313.64	1120.49
6.50	19.46	31.00	47.63	79.20	130.57	321.00	1251.21
6.62	19.53	31.72	47.92	79.99	132.50	328.29	1396.84
6.74	19.64	32.00	48.17	81.18	135.71	329.89	1413.32
7.10	20.00	32.11	48.74	81.50	136.75	337.71	1439.61
7.58	20.20	32.61	49.31	81.60	141.33	353.46	1501.00
7.93	20.39	33.12	49.88	83.19	142.46	357.41	1548.53
8.10	20.60	33.25	50.16	83.79	144.00	360.69	1800.00
8.25	20.95	33.65	50.49	84.56	146.20	367.60	1942.00
8.89	21.19	34.11	51.08	84.82	149.00	380.00	2000.00
9.49	21.42	34.18	51.66	86.53	151.43	385.45	2068.17
9.87	21.63	34.74	52.36	88.33	153.00	424.15	2119.40
10.12	21.65	34.84	52.98	90.13	156.25	430.17	2440.00
10.18	22.17	35.33	54.05	92.18	156.96	460.00	2825.51
10.30	22.80	36.27	54.39	92.43	163.06	471.01	3000.00
10.53	23.04	36.87	55.80	94.22	169.63	484.25	3075.00
12.20	23.37	37.01	57.23	96.37	172.29	500.18	3420.00
12.24	23.56	37.41	57.87	97.45	176.66	518.17	4240.00
12.55	24.00	37.69	58.07	98.79	184.18	518.52	5000.00
12.60	24.09	38.06	58.91	100.03	192.73	529.26	6500.00
12.70	24.83	38.89	59.71	100.94	195.52	552.50	9760.00
13.18	24.94	38.98	60.58	102.27	199.98	557.27	10000.00
13.58	25.24	39.25	61.44	102.76	201.86	605.94	13680.00
13.68	25.56	39.66	62.37	103.44	203.91	627.30	
14.00	25.83	40.38	63.35	106.01	211.93	642.98	
14.60	26.17	40.77	64.24	107.33	218.20	673.50	
14.88	26.33	40.90	65.22	223.16	691.41		

Laser Lenses

Laser Lenses

STANDARD BestForm LASER LENSES

OFR manufactures and maintains in stock its series of BestForm Laser Lenses. These are designed for minimum spherical aberration, and when not exceeding optimum beam diameter (see table below), will produce focal spots within diffraction-limit theory. These lenses can be used interchangeably for focusing, expanding or collimating.

Surface Quality

Polish exceeds 10-5 and sphericity better than 1/10-wave over the aperture at the

design wavelength. All lenses are polished to the highest spherical figure and fineness consistent with optimum performance in all respects: minimum blur-circle, minimum wavefront distortion, minimum scattering loss, and maximum transmittance of energy.

Antireflection Coatings

All lenses are available with narrow-band or broadband antireflection coatings peaked for the major wavelength of operation, at which transmittance will exceed 99%. When ordering, add wavelength (in nm) as final dash number in Catalog Part Number. For example, LL-25-63-633, etc.

BestForm Laser Lenses are designed with minimum aberration ratio of the radii of both surfaces.

Mechanical Specifications

Diameter	+0,-0.1 mm
Thickness	± 0.1 mm
Bevels	0.3 mm x 45°
Radii	± 2%



Laser Lenses for 157 nm* and 193 nm

LASER LENSES, 193 nm

OFR manufactures 193 nm Laser Lenses in two excimer-grades, CaF₂ and fused silica. OFR feels that optical performance of either type should be equivalent. However, in spite of significant improvements in materials since the arrival of the ArF laser, limited performance data leave questions unanswered.

Therefore, the choice of CaF₂ or fused silica is open to interpretation. Please discuss with OFR.

LASER LENSES, 157 nm

The new F₂ lasers at 157 nm promise finer resolution. However, currently available materials, such as CaF₂ and MgF₂, may be limited in performance at this short wavelength. Consequently, materials

producers are working diligently on improvements in order to meet growing demand.

Therefore, OFR is offering components, such as Laser lenses, in carefully selected materials. However, at this time, because of limitations not only in materials but also in methods of testing and verification, OFR will only supply components under strict terms and conditions. Please inquire.

LASER LENSES for ArF EXCIMER LASERS, 193 nm

Material Excimer Grade CaF₂
Design Wavelength 193 nm
Index at 193 nm 1.5045
CaF₂ transmits 130 nm-9.6 μm

Material Excimer Grade Fused Silica
Design Wavelength 193 nm
Index at 193 nm 1.5604
Fused Silica transmits 180 nm-2.3 μm

Wavelength	Bandwidth	Average Reflectance	Power Rating*
193nm	±5 nm	<0.5%	400 MW/cm ²

*Power rating based upon 20 n-s pulses, 20 Hz.

Catalog Number & Focal Length	Material	Size	Focal Length at 193 nm	Optimum Beam Dia.	Theoretical Focal Spot	R1 mm	R2 mm	Center Thickness
LLU-13-17-193	FS	1/2" dia.	17.4 mm	2.1 mm	2.0 μm	12.70	-38.89	3.5
LLU-13-17N-193	FS	1/2" dia.	-17.4 mm	2.1 mm	-	-12.70	44.62	2.5
LLV-13-20-193	CaF ₂	1/2" dia.	20.2 mm	2.4 mm	2.0 μm	12.20	-55.80	3.5
LLV-13-20N-193	CaF ₂	1/2" dia.	-20.0 mm	2.4 mm	-	-12.55	55.80	2.5
LLU-13-22-193	FS	1/2" dia.	21.8 mm	2.5 mm	2.2 μm	14.00	-79.99	3.5
LLU-13-22N-193	FS	1/2" dia.	-21.8 mm	2.5 mm	-	-14.60	79.99	2.5
LLV-13-25-193	CaF ₂	1/2" dia.	25.1 mm	2.8 mm	2.2 μm	14.00	-121.45	3.5
LLV-13-25N-193	CaF ₂	1/2" dia.	-25.1 mm	2.8 mm	-	-14.60	100.03	2.5
LLU-13-35-193	FS	1/2" dia.	34.8 mm	4.4 mm	2.4 μm	22.80	-121.45	3.5
LLU-13-35N-193	FS	1/2" dia.	-41.7 mm	4.4 mm	-	-22.80	141.32	2.5
LLV-13-40-193	CaF ₂	1/2" dia.	39.9 mm	4.0 mm	2.7 μm	23.56	-132.50	3.5
LLV-13-40N-193	CaF ₂	1/2" dia.	-40.3 mm	4.0 mm	-	-24.07	130.57	2.5
LLU-25-55-193	FS	1" dia.	54.8 mm	6.2 mm	2.7 μm	36.24	-192.73	5.5
LLV-25-63-193	CaF ₂	1" dia.	62.5 mm	5.6 mm	2.9 μm	37.85	-184.35	6.0
LLU-25-70-193	FS	1" dia.	69.6 mm	7.3 mm	3.0 μm	45.59	-265.14	5.5
LLV-25-80-193	CaF ₂	1" dia.	79.8 mm	6.6 mm	3.0 μm	47.65	-249.54	5.0
LLU-25-87-193	FS	1" dia.	87.0 mm	8.7 mm	3.1 μm	57.23	-326.28	5.0
LLV-25-100-193	CaF ₂	1" dia.	100.4 mm	7.9 mm	3.3 μm	58.07	-385.44	4.5
LLU-25-122-193	FS	1" dia.	122.4 mm	11.1 mm	3.3 μm	79.99	-471.01	5.0
LLV-25-140-193	CaF ₂	1" dia.	140.3 mm	10.1 mm	3.5 μm	81.50	-529.26	4.5
LLU-25-165-193	FS	1" dia.	165.3 mm	14.0 mm	3.6 μm	111.60	-529.26	5.0
LLV-25-190-193	CaF ₂	1" dia.	189.4 mm	12.7 mm	3.8 μm	109.13	-760.00	4.0
LLU-25-261-193	FS	1" dia.	261.0 mm	19.7 mm	4.0 μm	169.63	-1061.04	4.5
LLV-25-300-193	CaF ₂	1" dia.	300.5 mm	17.9 mm	4.3 μm	176.66	-1061.04	4.0

NOTE: Other diameters and focal lengths, and negative focal lengths, available on custom basis. Please inquire.

To order without AR coating, simply drop "-193". Thus, LLV-25-125, for example. Transmission of uncoated lens, 92%.

UV Laser Lenses

LASER LENSES for UV EXCIMER LASERS, 248 nm to 355 nm

Material UV Grade Silica

Design Wavelength 300 nm

Index at 300 nm 1.48779

UV fused silica transmits 180 nm-2.3 μm

Wavelength	Focal Length Correction
248 nm	-4%
300 nm	-
355 nm	+2%

Laser	λ
Nd:YAG	213 nm
KrF	248 nm
Nd:YAG	266 nm
XeCl	308 nm
HeCd	325 nm
N ₂	337 nm
XeF	351 nm
Nd:YAG	355 nm

NARROWBAND AR COATINGS

Specify λ between	Bandwidth at 5% of peak	Average Reflectance	Power Rating*
213-355 nm	~8%	< 0.2%	500 MW/cm ²

*Power rating based upon 20 n-sec pulses, 20 Hz

BROADBAND AR COATINGS

Description	Bandwidth	Average Reflectance	Power Rating*
UVB	240 - 360 nm	<0.5%	200 MW/cm ²
NUV	325 - 500 nm	<0.5%	200 MW/cm ²

*Power rating based upon 20 n-s pulses, 20 Hz.

For AR coating when ordering, insert AR coating at λ, for example, LLU-25-100-UVB or LLU-25-140-248, see page OC-14.

Catalog Number & Focal Length	Size	Focal Length at 300 nm	Optimum Beam Dia	Theoretical Focal Spot	Center Thickness	
					R1 mm	R2 mm
LLU-13-20-λ	1/2" dia.	20.1 mm	2.6 mm	2.5 μm	12.70	-38.89
LLU-13-20N-λ	1/2" dia.	-20.1 mm	2.6 mm	—	-22.70	44.62
LLU-13-25-λ	1/2" dia.	24.7 mm	3.1 mm	2.6 μm	14.00	-79.99
LLU-13-25N-λ	1/2" dia.	-25.1 mm	3.1 mm	—	-14.60	79.99
LLU-13-40-λ	1/2" dia.	40.0 mm	4.4 mm	3.5 μm	22.80	-121.45
LLU-13-40N-λ	1/2" dia.	-40.0 mm	4.4 mm	—	-22.80	141.32
LLU-25-63-λ	1" dia.	63.0 mm	6.2 mm	3.9 μm	36.24	-192.73
LLU-25-63N-λ	1" dia.	-62.2 mm	6.2 mm	—	-36.24	192.73
LLU-25-80-λ	1" dia.	80.2 mm	7.3 mm	4.2 μm	45.59	-265.14
LLU-25-80N-λ	1" dia.	-79.5 mm	7.3 mm	—	-45.59	265.14
LLU-25-100-λ	1" dia.	100.2 mm	8.7 mm	4.3 μm	57.23	-326.28
LLU-25-100N-λ	1" dia.	-99.6 mm	8.7 mm	—	-57.23	326.28
LLU-25-125-λ	1" dia.	124.6 mm	10.2 mm	4.7 μm	73.10	-353.46
LLU-25-125N-λ	1" dia.	-123.8 mm	10.2 mm	—	-73.10	356.46
LLU-25-140-λ	1" dia.	140.5 mm	11.1 mm	4.8 μm	79.99	-471.01
LLU-25-140N-λ	1" dia.	-139.9 mm	11.1 mm	—	-79.99	471.01
LLU-25-160-λ	1" dia.	161.2 mm	12.3 mm	5.0 μm	90.13	-605.94
LLU-25-190-λ	1" dia.	189.3 mm	14.0 mm	5.2 μm	111.60	-529.26
LLU-25-240-λ	1" dia.	241.7 mm	16.6 mm	5.5 μm	136.75	-848.13
LLU-25-300-λ	1" dia.	300.1 mm	19.7 mm	5.8 μm	169.63	-1061.04
LLU-25-300N-λ	1" dia.	-299.3 mm	19.7 mm	—	-169.63	1061.04
LLU-25-380-λ	1" dia.	381.5 mm	23.5 mm	6.2 μm	225.49	-1061.04
LLU-25-475-λ	1" dia.	482.7 mm	23.5 mm	7.7 μm	235.56	Plano
LLU-25-610-λ	1" dia.	620.6 mm	23.5 mm	9.9 μm	302.85	Plano
LLU-25-760-λ	1" dia.	789.8 mm	23.5 mm	12.3 μm	385.44	Plano
LLU-25-1000-λ	1" dia.	965.2 mm	23.5 mm	16.2 μm	471.01	Plano
LLU-25-2000-λ	1" dia.	2174.3 mm	23.5 mm	32.4 μm	1061.04	Plano
LLU-51-150-λ	2" dia.	150.5 mm	11.9 mm	4.8 μm	84.82	-529.26
LLU-51-190-λ	2" dia.	189.5 mm	14.0 mm	5.2 μm	111.60	-529.26
LLU-51-240-λ	2" dia.	238.1 mm	16.6 mm	5.5 μm	136.75	-760.00
LLU-51-300-λ	2" dia.	300.2 mm	19.7 mm	5.8 μm	169.63	-1061.04
LLU-51-380-λ	2" dia.	381.2 mm	23.5 mm	6.2 μm	225.22	-1061.04
LLU-51-475-λ	2" dia.	475.1 mm	27.8 mm	6.5 μm	260.90	-2068.17
LLU-51-610-λ	2" dia.	611.6 mm	33.6 mm	6.9 μm	357.41	-1800.00
LLU-51-760-λ	2" dia.	762.7 mm	39.5 mm	7.3 μm	438.93	-2440.00
LLU-51-1000-λ	2" dia.	992.3 mm	48.5 mm	7.9 μm	484.25	Plano

NOTE: Other diameters and focal lengths available on custom basis. Please inquire.

VIS-NIR Laser Lenses

LASER LENSES for VIS and NIR LASERS, 400 nm to 2.0 μm

Material Grade A 689382 Glass (SF8)
 Design Wavelength 650 nm
 Index at 650 nm 1.6835
 SF8 glass transmits from 360 nm - 2.3 μm

Wavelength	Focal Length Correction
488 nm	-3%
650 nm	-
1550 nm	+5%

BROADBAND AR COATINGS

Description	Bandwidth	Average Reflectance	Power Rating*
VIS	450 - 700 nm	< 0.5%	300 MW/cm ²
VIR	550 - 780 nm	< 0.5%	300 MW/cm ²
NIR	700 - 950 nm	< 0.5%	300 MW/cm ²
IR	1250 - 1550 nm	< 0.5%	300 MW/cm ²

*Power rating based upon 20 n-sec pulses, 20 Hz
 NOTE: Other AR coatings available, please inquire.

For Focal Lengths shorter than 20 mm, see page OC-9, FIBER-OPTIC COUPLING LENSES.

For AR coating when ordering, insert AR coating at λ , for example, LL-25-100-NIR, see page OC-14.

Catalog Number & Focal Length	Size	Focal Length at 650 nm	Optimum Beam Dia	Theoretical Focal Spot	R1 mm	R2 mm	Center Thickness
LL-13-20- λ	1/2" dia.	19.9 mm	3.1 mm	5.3 μm	13.58	plano	3.0
LL-13-20N- λ	1/2" dia.	-19.9 mm	3.1 mm	—	-13.58	plano	1.4
LL-13-25- λ	1/2" dia.	25.0 mm	3.7 mm	5.5 μm	17.10	plano	3.0
LL-13-25N- λ	1/2" dia.	-25.0 mm	3.7 mm	—	-17.10	plano	1.8
LL-25-40- λ	1" dia.	39.7 mm	5.4 mm	6.4 μm	27.18	plano	4.5
LL-25-40N- λ	1" dia.	-39.6 mm	5.4 mm	—	-27.08	plano	2.5
LL-25-63- λ	1" dia.	63.1 mm	7.5 mm	7.3 μm	43.16	plano	4.5
LL-25-63N- λ	1" dia.	-63.1 mm	7.5 mm	—	-43.16	plano	2.5
LL-25-80- λ	1" dia.	79.5 mm	9.0 mm	7.7 μm	54.39	plano	4.5
LL-25-80N- λ	1" dia.	-79.5 mm	9.0 mm	—	-54.39	plano	2.5
LL-25-100- λ	1" dia.	100.0 mm	10.7 mm	8.1 μm	68.39	plano	4.5
LL-25-100N- λ	1" dia.	-100.0 mm	10.7 mm	—	-68.39	plano	3.0
LL-25-125- λ	1" dia.	124.0 mm	12.6 mm	8.6 μm	84.82	plano	4.0
LL-25-125N- λ	1" dia.	-124.0 mm	12.6 mm	—	-84.82	plano	3.0
LL-25-140- λ	1" dia.	140.9 mm	13.7 mm	8.9 μm	96.37	plano	4.0
LL-25-140N- λ	1" dia.	-140.9 mm	13.7 mm	—	-96.37	plano	3.3
LL-25-160- λ	1" dia.	159.5 mm	15.2 mm	9.1 μm	109.13	plano	4.0
LL-25-160N- λ	1" dia.	-159.5 mm	15.2 mm	—	-190.13	plano	3.3
LL-25-190- λ	1" dia.	190.9 mm	17.3 mm	9.5 μm	130.57	plano	4.0
LL-25-190N- λ	1" dia.	-190.9 mm	17.3 mm	—	-130.57	plano	3.5
LL-25-240- λ	1" dia.	238.4 mm	20.6 mm	10.1 μm	163.06	plano	4.0
LL-25-240N- λ	1" dia.	-238.4 mm	20.6 mm	—	-163.06	plano	3.5
LL-25-300- λ	1" dia.	298.1 mm	24.3 mm	10.7 μm	203.91	plano	4.0
LL-25-380- λ	1" dia.	381.4 mm	24.3 mm	13.6 μm	260.90	plano	4.0
LL-25-475- λ	1" dia.	477.0 mm	24.3 mm	17.0 μm	326.28	plano	4.0
LL-25-610- λ	1" dia.	620.1 mm	24.3 mm	21.8 μm	424.15	plano	4.0
LL-25-760- λ	1" dia.	757.6 mm	24.3 mm	27.2 μm	518.17	plano	4.0
LL-25-1000- λ	1" dia.	1010.2 mm	24.3 mm	35.7 μm	691.00	plano	4.0
LL-51-190- λ	2" dia.	189.0 mm	17.3 mm	9.5 μm	129.30	plano	7.0
LL-51-240- λ	2" dia.	238.4 mm	20.6 mm	10.1 μm	163.06	plano	6.0
LL-51-300- λ	2" dia.	298.1 mm	24.3 mm	10.7 μm	203.91	plano	6.0
LL-51-380- λ	2" dia.	381.4 mm	29.0 mm	11.4 μm	260.90	plano	6.0
LL-51-475- λ	2" dia.	477.0 mm	34.3 mm	12.0 μm	326.28	plano	5.0
LL-51-610- λ	2" dia.	620.1 mm	41.4 mm	12.8 μm	424.15	plano	5.0
LL-51-760- λ	2" dia.	757.6 mm	48.8 mm	13.5 μm	518.17	plano	4.5
LL-51-1000- λ	2" dia.	1010.8 mm	48.8 mm	17.8 μm	691.41	plano	4.5

NOTE: Other diameters and focal lengths available on custom basis. Please inquire.

YAG Laser Lenses

LENSES for YAG LASERS, 1064nm

Material Fused Silica
 Design Wavelength 1064 nm
 Index at 1064 nm 1.4503
 Fused silica transmits 200 nm-2.3 μ m

ANTIREFLECTION COATING			
Wavelength	Bandwidth	Average Reflectance	Power Rating*
1064 nm	± 40 nm	0.1-0.2%	2 GW/cm ²

*Power rating based upon 20 n-sec pulses, 20 Hz

To order without AR coating, simply drop "-YAG". Thus, LLQ 25-125, for example.

Catalog Number & Focal Length	Size	Focal Length at 1064 nm	Optimum Beam Dia	Theoretical Focal Spot	R1 mm	R2 mm	Center Thickness
LLQ-13-20-YAG	1/2" dia.	20.0 mm	3.6 mm	7.5 μ m	10.53	-54.39	4.0
LLQ-13-20N-YAG	1/2" dia.	-20.1 mm	3.6 mm	—	-10.53	61.44	2.0
LLQ-13-25-YAG	1/2" dia.	25.1 mm	4.2 mm	8.0 μ m	13.58	-62.37	3.0
LLQ-13-25N-YAG	1/2" dia.	-25.0 mm	4.2 mm	—	-14.00	59.70	2.1
LLQ-13-40-YAG	1/2" dia.	30.0 mm	6.0 mm	9.0 μ m	21.64	-88.33	3.0
LLQ-13-40N-YAG	1/2" dia.	-40.1 mm	6.0 mm	—	-22.80	88.33	2.0
LLQ-25-63-YAG	1" dia.	63.0 mm	8.4 mm	10.1 μ m	34.74	-146.20	5.5
LLQ-25-63N-YAG	1" dia.	-62.1 mm	8.4 mm	—	-34.18	156.96	2.5
LLQ-25-80-YAG	1" dia.	80.4 mm	10.1 mm	10.7 μ m	44.62	-184.18	5.0
LLQ-25-80N-YAG	1" dia.	-80.3 mm	10.1 mm	—	-45.11	184.18	2.5
LLQ-25-100-YAG	1" dia.	99.8 mm	11.9 mm	11.4 μ m	55.80	-223.16	5.0
LLQ-25-100N-YAG	1" dia.	-98.9 mm	11.9 mm	—	-55.80	223.16	3.0
LLQ-25-125-YAG	1" dia.	124.5 mm	14.1 mm	12.0 μ m	69.50	-282.77	5.0
LLQ-25-125N-YAG	1" dia.	-124.9 mm	14.1 mm	—	-69.50	297.94	3.0
LLQ-25-140-YAG	1" dia.	141.1 mm	15.3 mm	12.4 μ m	75.77	-385.44	4.5
LLQ-25-140N-YAG	1" dia.	-140.3 mm	15.3 mm	—	-77.09	353.46	3.0
LLQ-25-160-YAG	1" dia.	160.1 mm	17.0 mm	12.7 μ m	86.53	-424.15	4.5
LLQ-25-160N-YAG	1" dia.	-159.4 mm	17.0 mm	—	-86.53	424.15	3.0
LLQ-25-190-YAG	1" dia.	189.0 mm	19.3 mm	13.3 μ m	106.01	-424.15	4.5
LLQ-25-190N-YAG	1" dia.	-190.1 mm	19.3 mm	—	-103.44	498.40	3.0
LLQ-25-240-YAG	1" dia.	240.2 mm	23.0 mm	14.1 μ m	128.47	-674.00	4.5
LLQ-25-300-YAG	1" dia.	303.9 mm	23.0 mm	17.6 μ m	136.75	plano	4.0
LLQ-25-380-YAG	1" dia.	383.2 mm	23.0 mm	22.3 μ m	172.45	plano	4.0
LLQ-25-475-YAG	1" dia.	471.0 mm	23.0 mm	27.9 μ m	211.93	plano	4.0
LLQ-25-610-YAG	1" dia.	598.1 mm	23.0 mm	35.8 μ m	269.13	plano	4.0
LLQ-25-760-YAG	1" dia.	750.5 mm	23.0 mm	44.7 μ m	337.71	plano	4.0
LLQ-25-1000-YAG	1" dia.	1022.2 mm	23.0 mm	58.8 μ m	460.00	plano	4.0
LLQ-51-150-YAG	2" dia.	150.3 mm	16.2 mm	12.5 μ m	81.50	-385.44	8.0
LLQ-51-190-YAG	2" dia.	189.2 mm	19.3 mm	13.3 μ m	106.01	-424.15	7.0
LLQ-51-240-YAG	2" dia.	238.8 mm	23.0 mm	14.1 μ m	130.57	-598.30	6.5
LLQ-51-240N-YAG	2" dia.	-240.7 mm	23.0 mm	—	-132.50	598.30	4.0
LLQ-51-300-YAG	2" dia.	299.0 mm	27.2 mm	14.9 μ m	163.06	-760.00	6.5
LLQ-51-380-YAG	2" dia.	380.6 mm	32.4 mm	15.8 μ m	203.91	-1061.04	5.5
LLQ-51-475-YAG	2" dia.	474.6 mm	38.3 mm	16.8 μ m	263.43	-1120.49	5.5
LLQ-51-610-YAG	2" dia.	628.2 mm	46.3 mm	17.8 μ m	282.69	plano	5.0
LLQ-51-760-YAG	2" dia.	750.5 mm	46.3 mm	22.2 μ m	337.71	plano	4.5
LLQ-51-1000-YAG	2" dia.	1022.2 mm	46.3 mm	29.2 μ m	460.00	plano	4.5

NOTE: Other diameters and focal lengths available on custom basis. Please inquire.

Air-Spaced Doublet Lens Assemblies

UV-VIS Achromatic

Over the years, we have designed many unique achromatic lens systems and collimators to cover the UV through visible. These designs include monochromator input collimators, imaging systems and other specially designed systems.

Please inquire about our library of such designs. It is possible that we have already built a system to meet a special application.

Utilizing such a design or a modification thereof may likely avoid the expense of a new design.

Below are listed some of our standard UV-VIS Achromatic Lenses. These are corrected for the infinite conjugate, that is optimized for focusing an infinitely distant object, or for collimating from a point source at the focal point.

PLEASE NOTE: Because light sources are extended, that is of finite size, it is difficult to describe image quality in terms of theoretical blur-circles.

These are air-spaced doublets consisting of one element of calcium fluoride with the other of UV grade fused silica, uncoated, mounted in our standard black anodized cell.

Design details available on request.

Catalog Number	Clear Aperture	Focal Length	Design Spectrum	Cell Dimension
LAU-25-100	22 mm dia.	100 mm	200 - 500 nm	1.3 dia. x ¾"
LAU-25-200	22 mm dia.	200 mm	200 - 500 nm	1.3 dia. x ¾"
LAU-51-200	48 mm dia.	200 mm	200 - 500 nm	2.3 dia. x 1"

Visible Achromatic

Our two-element, air-spaced achromats are designed for diffraction-limited focusing in the visible spectrum.

The lenses are mounted in a black-anodized cell. All four surfaces are anti-reflection coated for the visible spectrum so that transmittance exceeds 96%.

These are "fast" lenses, being f/4, and designed for focusing or collimating.

Catalog Number	Effective Focal Length	Back Focal Length	Clear Aperture	Lens 1, BK7				Lens 2, SF11			Cell Dimensions
				R1	R2	C _t	T _{AIR}	R3	R4	C _t	
LLA-25-100-VIS	100 mm	95.08	22 mm	57.87	-62.37	4.50	0.24	-58.07	-121.45	4.00	1.5" dia. x ½"
LLA-51-200-VIS	200 mm	196.32	48 mm	114.88	-136.75	9.30	3.00	-121.45	-269.13	5.80	2.5" dia. x 1"
LLA-76-300-VIS	300 mm	280.36	73 mm	163.06	-198.00	11.00	6.20	-172.29	-385.44	8.00	3.5" dia. x 1½"
LLA-102-400-VIS	400 mm	382.66	99 mm	211.99	-282.80	19.00	5.10	-249.40	-598.00	6.20	4.5" dia. x 1¾"
LLA-152-600-VIS	600 mm	585.60	149 mm	353.34	-385.45	20.0	0.35	-357.19	-735.50	12.00	7.0" dia. x 2"

Laser Collimators

Our Laser Collimator Lenses are designed for monochromatic operation at any laser wavelength from 400 nm to 1.5 μm, and will focus within diffraction-limit theory.

These "fast" f/4 air-spaced doublets are mounted in a black anodized cell. All surfaces are antireflection coated so that transmittance will exceed 96% at the specified wavelength of operation.

When ordering, specify wavelength for antireflection coatings. Other Laser Collimator Lenses are available. Please inquire.



Catalog Number	Nominal Focal Length	Back Focal Length	Clear Aperture	Lens 1, BK7				Lens 2, SF11			Cell Dimensions
				R1	R2	C _t	T _{AIR}	R3	R4	C _t	
LLS-25-100-λ	100mm	95.08	22 mm	57.87	-62.37	4.50	0.24	-58.07	-121.45	4.00	1.5" dia. x ½"
LLS-51-200-λ	200mm	196.32	47 mm	114.88	-136.75	9.30	3.00	-121.45	-269.13	5.80	2.5" dia. x 1"
LLS-76-300-λ	300mm	280.36	72 mm	163.06	-198.00	11.00	6.20	-172.29	-385.44	8.00	3.5" dia. x 1½"
LLS-102-400-λ	400mm	382.66	98 mm	211.99	-282.80	19.00	5.10	-249.40	-598.00	6.20	4.5" dia. x 1¾"
LLS-152-600-λ	600mm	575.40	147 mm	328.89	-471.12	21.00	1.40	-385.45	-1500.00	16.3	7.0" dia. x 2"

NOTE: specify λ from 400nm to 1.5 μm, for example LLS-25-100-633.

Cylindrical Lenses

Cylindrical Lenses

OFR manufactures plano-convex/concave Cylindrical Lenses in Grade A BK7 glass, Excimer Grade CaF₂, and UV Grade Fused Silica.

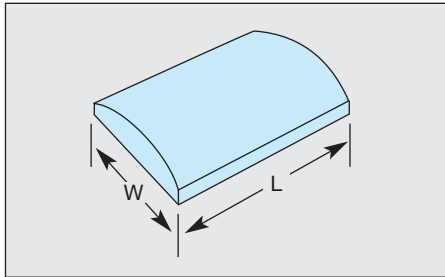
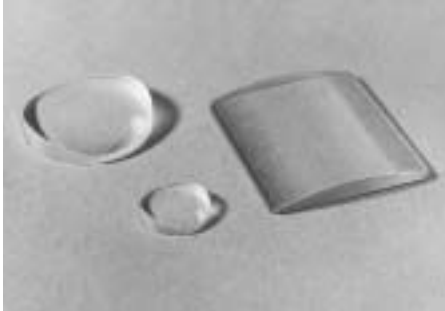

Profile, cylindrical lens

ULTRAVIOLET CYLINDRICAL LENSES for ArF Laser, 193 nm (Excimer-Grade CaF₂)

Catalog Number	Focal Length	Width x Length
LCV-15x20-20	20 mm	15 x 20 mm
LCV-20x20-40	40 mm	20 x 20 mm
LCV-20x20-80	80 mm	20 x 20 mm
LCV-20x20-100	100 mm	20 x 20 mm
LCV-20x20-200	200 mm	20 x 20 mm

Other diameters and focal lengths, and negative focal lengths, available on custom basis. Please Inquire.

CYLINDRICAL LENSES for Excimer & UV Lasers, 193 nm-355 nm (UV-Grade Fused Silica)

Catalog Number	Focal Length	Width x Length	Laser	λ
LCU-15x20-20	20 mm	15 x 20 mm	ArF	193 nm
LCU-20x20-40	40 mm	20 x 20 mm	KrF	248 nm
LCU-20x20-80	80 mm	20 x 20 mm	Nd:YAG	266 nm
LCU-20x20-100	100 mm	20 x 20 mm	XeCl	308 nm
LCU-20x20-200	200 mm	20 x 20 mm	HeCd	325 nm
			N ₂	337 nm
			XeF	351 nm
			Nd:YAG	355 nm

Other diameters and focal lengths, and negative focal lengths, available on custom basis. Please Inquire.

CYLINDRICAL LENSES for 400nm-2.5 μ m (Grade A BK7 Glass)

Positive Focal Length Catalog Number	Negative Focal Length Catalog Number	Focal Length	Width x Length
LC-4x5-4	—	4 mm	4 x 5 mm
LC-7x10-8	LC-7x10-8N	8 mm	7 x 10 mm
LC-10x10-10	—	10 mm	10 x 10 mm
LC-10x20-15	LC-10x10-15N	15 mm	10 x 20 mm
LC-15x20-20	—	20 mm	15 x 20 mm
LC-20x20-25	LC-20x20-25N	25 mm	20 x 20 mm
LC-20x20-40	LC-20x20-40N	40 mm	20 x 20 mm
LC-20x20-60	LC-20x20-60N	60 mm	20 x 20 mm
LC-20x20-80	—	80 mm	20 x 20 mm
LC-20x20-100	LC-20x20-100N	100 mm	20 x 20 mm
LC-20x20-150	—	150 mm	20 x 20 mm
LC-20x20-200	—	200 mm	20 x 20 mm
LC-20x20-300	—	300 mm	20 x 20 mm
LC-20x20-500	—	500 mm	20 x 20 mm
LC-20x20-1000	—	1000 mm	20 x 20 mm

Other diameters and focal lengths, and negative focal lengths, available on custom basis. Please Inquire.

CYLINDRICAL LENSES for High Power YAG Lasers, 1064 nm (Fused Silica)

Positive Focal Length Catalog Number	Negative Focal Length Catalog Number	Focal Length	Width x Length
LCQ-10x10-10	—	10 mm	10 x 10 mm
LCQ-10x20-15	LC-10x10-15N	15 mm	10 x 20 mm
LCQ-15x20-20	—	20 mm	15 x 20 mm
LCQ-20x20-25	LC-20x20-25N	25 mm	20 x 20 mm
LCQ-20x20-40	LC-20x20-40N	40 mm	20 x 20 mm
LCQ-20x20-60	LC-20x20-60N	60 mm	20 x 20 mm
LCQ-20x20-80	—	80 mm	20 x 20 mm
LCQ-20x20-100	LC-20x20-100N	100 mm	20 x 20 mm
LCQ-20x20-150	—	150 mm	20 x 20 mm
LCQ-20x20-200	—	200 mm	20 x 20 mm

Other diameters and focal lengths, and negative focal lengths, available on custom basis. Please Inquire.

Microscope Objectives

Microscope Objectives, VIS-NIR

OFR stocks this fine line of exceptionally high quality Microscope Objective Lens assemblies, which are ideally suited for focusing laser beams to spot sizes not otherwise achievable with standard optics, as well as for their original use in magnification systems. Our Microscope Objective Lenses are contained in very fine, brushed chrome-plated brass barrels with the industry standard RMS (Royal Microscopy Society) Whitworth screw thread. We also provide our LMO-51 Mounting Plate with this unique thread.

These are for use with low-power, visible to near-IR sources. For UV excimer and high power YAG laser applications, please see **MicroSpot FOCUSING OBJECTIVES**.



LMO-51 Mounting Plate



LMO Objectives, AR coated for visible spectrum

Catalog Number	Description	Size
LMO-51	Mounting Plate	2" dia. x 1/2"

Catalog Number	Magnification	Approx. Limiting Resolution	Effective Focal Length	Working Distance	Numerical Aperture	Angular Aperture
LMO-2X	2X	7 μm	47 mm	48/49 mm	0.07	8°
LMO-5X	5X	4 μm	30 mm	18/20 mm	0.12	14°
LMO-10X	10X	2 μm	16 mm	5/6 mm	0.30	35°
LMO-20X	20X	1 μm	9 mm	1.6/1.8 mm	0.45	53°
LMO-40X	40X	0.8 μm	5 mm	0.6/0.8 mm	0.65	81°
LMO-60X	60X	0.2 μm	3 mm	0.25/0.35 mm	0.85	116°

Fiber-Optic Coupling Lenses

MOUNTED LLO SERIES LENSES are A/R coated and mounted in a Microscope Objective Cell with industry standard RMS thread. Other mounting options available. Please inquire.

UNMOUNTED LL SERIES LENSES, as above, but unmounted. See page FO-36 in FIBER-OPTIC PRODUCTS section.



MOUNTED DOUBLE-ASPHERIC LENSES

Catalog Number	Focal Length	Working Distance	Numerical Aperture	Maximum Beam Dia.	Magnification
LLO-4-18- λ^*	18.4 mm	17.0 mm	0.13	4.4 mm	10X
LLO-6-11- λ	11.0 mm	9.1 mm	0.30	6.5 mm	16X
LLO-8-8- λ^*	8.0 mm	5.5 mm	0.50	8.0 mm	20X
LLO-4-7- λ	7.5 mm	5.5 mm	0.30	4.5 mm	24X
LLO-4-4- λ	4.6 mm	2.4 mm	0.53	4.8 mm	40X
LLO-2-2- λ^*	2.0 mm	0.9 mm	0.50	2.0 mm	60X

*Not available for HoYAG. NOTE: When ordering, specify wavelength, for example, LLO-4-4-NIR.

UNMOUNTED DOUBLE-ASPHERIC LENSES

Catalog Number	Focal Length	Back Focal Length	Center Thickness	Numerical Aperture	Diameter
LL-3-2- λ	2.0 mm	0.9 mm	2.0	0.50	3.0 mm
LL-5-7- λ	7.5 mm	5.8 mm	2.7	0.30	5.5 mm
LL-6-11- λ	11.0 mm	9.6 mm	2.2	0.30	6.0 mm
LL-6-5- λ	4.6 mm	2.9 mm	3.1	0.53	6.0 mm

*Not available for HoYAG. NOTE: When ordering, specify wavelength, for example, LL-3-2-IR.

Max T Spectrum	Order as
380 - 640 nm	-VIS
600 - 990 nm	-NIR
970 - 1100 nm	-YAG
1250 - 1600 nm	-IR
1.9 - 2.15 μm	-HoYAG*

*LL-3-2, LLO-2-2 and LLO-8-8 not available for HoYAG

Laser Beam Expanders

We have subdivided our Laser Beam Expanders into three basic wavelength ranges: UV LASERS, VIS-NIR LASERS, and HIGH-POWER LASERS (primarily Nd:YAG).

OFR manufactures Laser Beam Expanders which are basically custom-assembled according to specific requirements of the application. The telescope body consists of two black anodized, close-fitting tubes which rotate in or out of each other, locking screws, and a matched pair of Lenses: the Input Expander and the Output Collimator. Actually, these Lenses are based on our minimum aberration BestForm Laser Lenses (see page OC-3) which are matched so as to produce a collimated beam whose wavefront distortion is consistent with diffraction theory, namely $\frac{1}{4}$ -wave or better.

The simple telescope body enables adjustment of the spacing between the lenses for focusing, collimating or diverging.

In general, we can match any combination of our BestForm Lenses to meet a very wide variety of conditions and expansion ratios from 2.5X to 50X.

The Lenses are multilayer antireflection coated for peak transmittance of > 96% through the pair.

We will specifically fabricate custom brackets or adapters to fit the telescope to existing apparatus as required.

The EL-25-series and ELQ-25-series Telescopes are 1.5" diameter x 4" long expanding to 7" long depending upon lens combinations required. Likewise, the EL-51-series and the ELQ -51-series are 2.5" diameter x 8" long expanding to 12" long.



UV Laser Beam Expanders

OFR BestForm Laser Lenses (see page OC-4), selected from our LLU-Series, are made in UV grade fused silica. Lenses are AR coated at peak wavelength, with transmittance >96%.

Laser	λ (nm)
KrF	248
Nd:YAG	266
XeCl	308
HeCd/N ₂	325/337
XeF	351

Catalog Number	Expansion Ratio	Max. Input Beam Dia.*	Output Aperture
ELU-25-2.5X- λ	2.5X	4 mm	22 mm
ELU-25-5X- λ	5X	3 mm	22 mm
ELU-25-10X- λ	10X	2 mm	22 mm
ELU-25-20X- λ	20X	1 mm	22 mm
ELU-51-25X- λ	25X	1.5 mm	48 mm

λ : When ordering, specify wavelength for AR coatings.
*Exceeding "Maximum Input Beam Diameter" will increase wavefront distortion beyond $\lambda/4$.

VIS-NIR LASER BEAM EXPANDERS

Please see page OC-5 for descriptions of our LL-Series of BestForm Laser Lenses which are selected for the optimum combinations to achieve both expansion ratio and a diffraction-limited output wavefront. Both surfaces of each lens are broadband antireflection coated to cover the spectrum as shown in the following table. Anywhere in the specified spectrum, the Beam Expander will transmit > 96%.

Catalog Number	Expansion Ratio	Max. Input Beam Dia.*	Output Aperture
EL-25-2.5X- λ	2.5X	4 mm	22 mm
EL-25-5X- λ	5X	3 mm	22 mm
EL-25-10X- λ	10X	2 mm	22 mm
EL-25-20X- λ	20X	1 mm	22 mm
EL-51-25X- λ	25X	1.5 mm	48 mm

λ : When ordering, specify wavelength for AR coatings.
*Exceeding "Maximum Input Beam Diameter" will increase wavefront distortion beyond $\lambda/4$.
Other wavelengths available.

Laser	Bandwidth	Order as
Visible	425 - 675 nm	-VIS
Gas/Dye	550 - 780 nm	-VIR
NIR Diodes	750 - 950 nm	-NIR
IR Diodes	1250 -1550 nm	-IR

Laser Beam Expanders

High-Power YAG Beam Expanders

The lenses selected for use in this series are our minimum aberration LLQ-Series which are described on page OC-6. These lenses are in optical grade fused silica; the multilayer antireflection coatings are peaked at 1064 nm below, and the pair of lenses will transmit > 96%.

Laser	λ (nm)
Nd:YAG	1064

Catalog Number	Expansion Ratio	Max. Input Beam Dia.*	Output Aperture
ELQ-25-2.5X-YAG	2.5X	4 mm	22 mm
ELQ-25-5X-YAG	5X	3 mm	22 mm
ELQ-25-10X-YAG	10X	2 mm	22 mm
ELQ-25-20X-YAG	20X	1 mm	22 mm
ELQ-51-7.5X-YAG	7.5X	6 mm	48 mm
ELQ-51-10X-YAG	10X	4 mm	48 mm
ELQ-51-15X-YAG	15X	3 mm	48 mm
ELQ-51-20X-YAG	20X	2 mm	48 mm
ELQ-51-40X-YAG	40X	1 mm	48 mm

*Exceeding "Maximum Input Beam Diameter" will increase wavefront distortion beyond $\lambda/4$.



OFR will design and build custom Beam Expanders. Please inquire.

Flat-Top Apodizer (GAUSSIAN COMPENSATING PLATE), VIS-NIR

For applications in which it is necessary to equalize the energy density across an expanded laser beam, the Flat-Top Apodizer Plate utilizes a plano-convex, neutral gray glass lens cemented against a plano-concave, clear glass lens. The result is a plane-parallel plate with a radially-varying neutral attenuation. With a correctly expanded beam, this combination produces a "flat-top" energy distribution from a Gaussian beam, with ~35% of the original laser power retained. Antireflection coatings are not available.

Antireflection coatings are not available.

Catalog Number	Dimensions
GC-25	1" dia. x 1/4" thick
GC-51	2" dia. x 1/4" thick

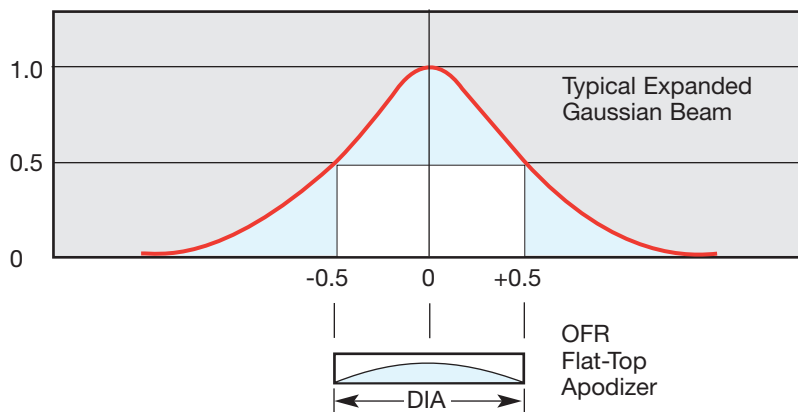

Ideal "flat-top" condition occurs when 50% of central zone intensity corresponds to diameter of Flat-Top Apodizer Plate



Front-Surface Mirrors

OFR manufactures and maintains a stock of standard Front-Surface Mirrors, with opaque, vacuum-deposited metallic coatings on low-expansion glass substrates. These coatings are not intended for high-power laser applications.

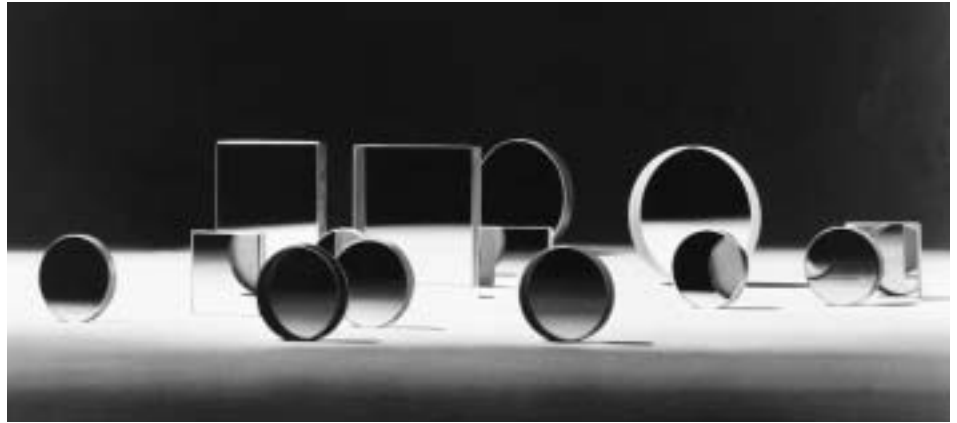

Material	Pyrex
Dimensions	
Diameter	+0,-0.1 mm
Thickness	±0.1 mm
Parallel	3-5'
Optical	
Flatness	1/4-1/10 wave
Polish	20/10
Rear	Fine ground

Front-Surface Metallic Coatings

Ultraviolet (MU)

This is an aluminum coating with a thin film of magnesium fluoride overcoat which protects the aluminum and is reflective to the short wavelengths. This coating can be somewhat delicate, and care should be taken when cleaning.

Visible-Near Infrared (M)

This is the most common of the "aluminized" mirror coatings. It is an aluminum coating with a protective overcoat of SiO₂.

Hard Gold (MR)

This hard gold coating is intended for the infrared. It is not always necessary to go to the expense of the gold coating if the standard aluminum coating performs as well. Please inquire.

High Reflectance (MH)

This is also a Visible-Near IR coating, except that the reflectance in the visible spectrum is enhanced with dielectric overlayers.

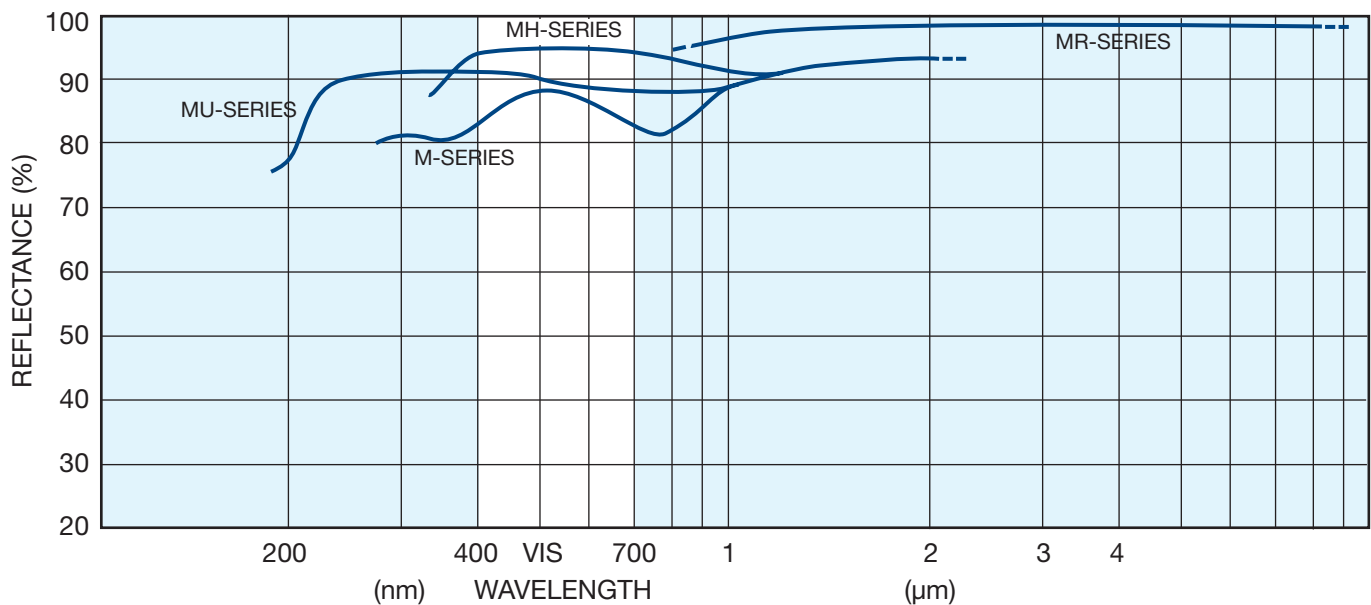

Front-Surface Mirrors

ULTRAVIOLET MIRRORS (160 nm to Far IR)

This coating is delicate, with a very thin layer of MgF₂ over the aluminum film to prevent oxidation. These will not withstand high energy excimer laser radiation. Clean carefully with methanol or acetone.

Catalog Number	Spectral Range	Dimensions	Coating/overcoat	Reflectance	Surface Flatness
MU-25	160 nm - Far IR	1" dia. x ¼"	Aluminum/MgF ₂	60-90%	¼-wave
MU-51	160 nm - Far IR	2" dia. x ¼"	Aluminum/MgF ₂	60-90%	¼-wave

VISIBLE MIRRORS (380 nm to Far IR)

Our Standard Mirrors, with protective silicon monoxide overcoat on the aluminum film, meet eraser and adherence tests, with reflectance greater than 86% throughout the visible spectrum. Because of a small absorption dip near 800 nm, we recommend our IR Mirrors (see next group below) for use with NIR sources.

Catalog Number	Spectral Range	Dimensions	Coating/overcoat	Reflectance	Surface Flatness
M-25	380 nm - Far IR	1" dia. x ¼"	Aluminum/SiO	Above 86%	¼-wave
M-51	380 nm - Far IR	2" dia. x ¼"	Aluminum/SiO	throughout	¼-wave
M-76	380 nm - Far IR	3" dia. x ½"	Aluminum/SiO	visible	¼-wave
M-102	380 nm - Far IR	4" dia. x ¾"	Aluminum/SiO	spectrum	¼-wave
M-152	380 nm - Far IR	6" dia. x 1"	Aluminum/SiO		¼-wave

INFRARED MIRRORS (700 nm to Far IR)

Our Infrared Mirrors have hard, scratch-resistant gold mirror coatings giving a maximum of reflectance throughout the near and far IR to an average of 98.5%.

Catalog Number	Spectral Range	Dimensions	Coating/overcoat	Reflectance	Surface Flatness
MR-25	700 nm - Far IR	1" dia. x ¼"	Protected Gold	98.5%	¼-wave
MR-51	700 nm - Far IR	2" dia. x ¼"	Protected Gold	98.5%	¼-wave

HIGH-REFLECTANCE MIRRORS (425 nm to Far IR)

This aluminized Mirror has dielectric overlayers which enhance reflectance in the visible spectrum to an average of 95% and which increases to 98% in the IR.

Catalog Number	Spectral Range	Dimensions	Coating/overcoat	Reflectance	Surface Flatness
MH-25	425 nm - Far IR	1" dia. x ¼"	Aluminum/dielectric	Above 95%	¼-wave
MH-51	425 nm - Far IR	2" dia. x ¼"	Aluminum/dielectric	Above 95%	¼-wave

LAMBDA-OVER-20 MIRRORS (425 nm to Far IR)

These interferometer-quality mirrors are coated with our High-Reflectance Coating.

Catalog Number	Spectral Range	Dimensions	Coating/overcoat	Reflectance	Surface Flatness
MI-25	425 nm - Far IR	1" dia. x ¼"	Aluminum/dielectric	Above 95%	½ ₂₀ -wave
MI-51	425 nm - Far IR	2" dia. x ½"	Aluminum/dielectric	Above 95%	½ ₂₀ -wave
MI-76	425 nm - Far IR	3" dia. x ½"	Aluminum/dielectric	Above 95%	½ ₂₀ -wave
MI-102	425 nm - Far IR	4" dia. x ¾"	Aluminum/dielectric	Above 95%	½ ₂₀ -wave
MI-152	425 nm - Far IR	6" dia. x 1"	Aluminum/dielectric	Above 95%	½ ₂₀ -wave

Dielectric Laser Coatings

Most of the OFR optical components are supplied coated; we will also apply coatings as requested on any of our normally uncoated parts. The following tables describe our dielectric coatings.



Reflection and Partial Reflection Coatings

NARROWBAND COATINGS Bandwidth shown is at $\pm 5\%$ of peak

Ordering Description	Select λ Between	Bandwidth	Maximum Reflectance	Power Rating*
UV	193-400 nm	6-8%	99.5%	300 MW/cm ²
VIS-NIR	400 nm-2.0 μ m	20%	99.5%	500 MW/cm ²
HIGH-POWER	400 nm-2.0 μ m	10%	99.8%	500 MW/cm ²

BROADBAND COATINGS Bandwidth per table below.

Ordering Description	Bandwidth	Average Reflectance	Power Rating*
VIS	450-675 nm	99%	200 MW/cm ²
NIR	700-900 nm	99%	400 MW/cm ²
IR	1250-1550 nm	99%	400 MW/cm ²

*Power rating based upon 20 n-sec pulses, 20 Hz

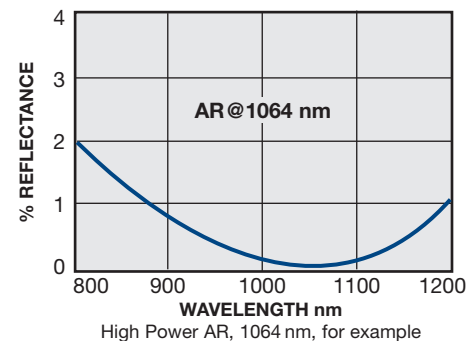
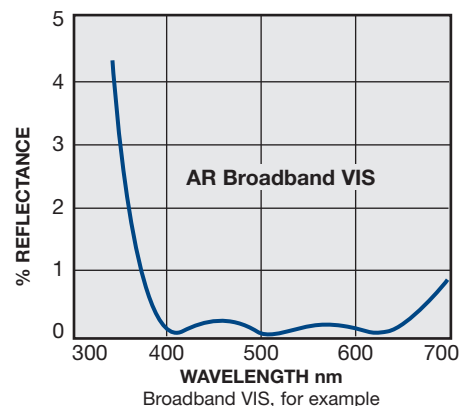
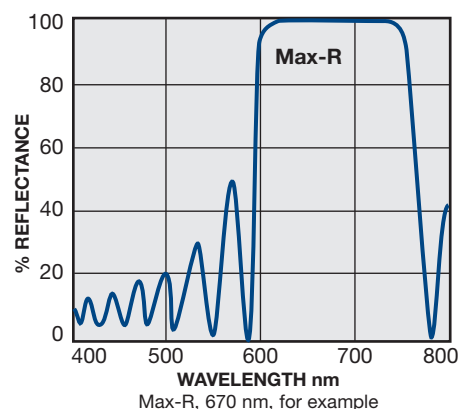

Antireflection Coatings

NARROWBAND AR COATINGS Bandwidth shown is at $\pm 5\%$ of peak

Ordering Description	Select λ Between	Bandwidth	Maximum Reflectance	Power Rating*
VUV	193 nm	± 2 nm	< 0.7%	400 MW/cm ²
UV	220-400 nm	8%	< 0.3%	500 MW/cm ²
VIS-NIR & HP	400 nm - 2.0 μ m	12%	0.1-0.2%	2 GW/cm ²
CO ₂	10.6 μ m	10%	< 0.5%	>800 W/cm ²

BROADBAND AR COATINGS Bandwidth per table below.

Ordering Description	Bandwidth	Absolute Reflectance	Power Rating*
UVB	240 - 360 nm	< 0.5%	200 MW/cm ²
NUV	325 - 500 nm	< 0.5%	200 MW/cm ²
VIS	450 - 700 nm	< 0.5%	300 MW/cm ²
VIR	550 - 780 nm	< 0.5%	300 MW/cm ²
NIR	700 - 950 nm	< 0.5%	300 MW/cm ²
IR	1250 - 1550 nm	< 0.5%	300 MW/cm ²

*Power rating based upon 20 n-sec pulses, 20 Hz

Broadband Reflectors and Beamsplitters

Broadband MAX-R Reflectors, 0° & 45°

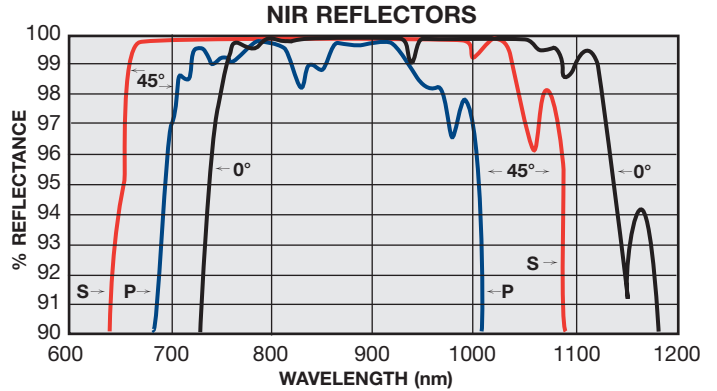
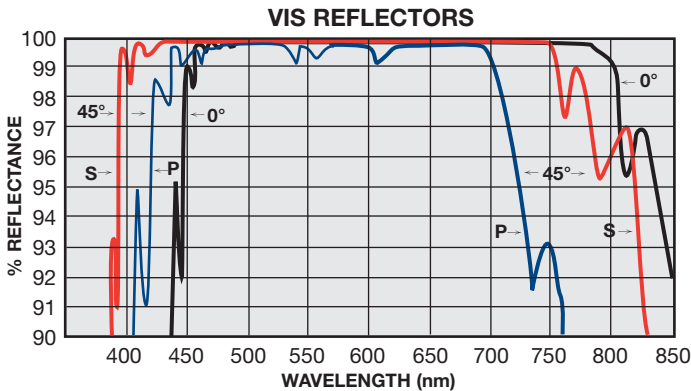

VIS REFLECTORS

Catalog Number	Dimensions	Reflectance	Damage Threshold
MXY-25-VIS	1" dia. x 1/4"	>99%	>50 MW/cm ² *
MXY-51-VIS	2" dia. x 1/4"	>99%	>50 MW/cm ² *

*20 ns pulses, 10 Hz

NIR REFLECTORS

Catalog Number	Dimensions	Reflectance	Damage Threshold
MXY-25-NIR	1" dia. x 1/4"	>99%	>350 MW/cm ² *
MXY-51-NIR	2" dia. x 1/4"	>99%	>350 MW/cm ² *

*20 ns pulses, 10 Hz

Material	BK7 glass
Dimensions	
Diameter	+0,-0.1 mm
Thickness	±0.1 mm
Parallel	3-5'
Optical	
Flatness	1/20 wave
Polish, both sides	10/5

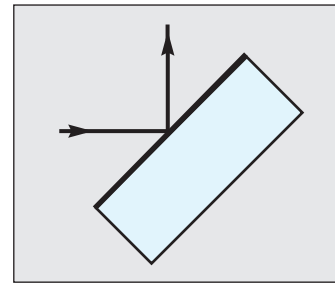
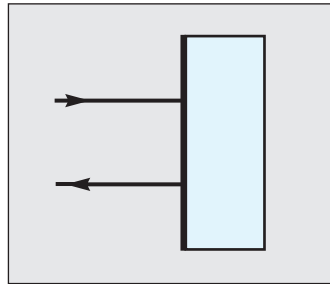

Broadband VIS Beamsplitters, 45°

BROADBAND BEAMSPLITTERS

Catalog Number	Dimensions	Percent R/T	Damage Threshold
MSA-25-VIS-50/50	1" dia. x 1/4"	50/50	300 MW/cm ² *
MSA-51-VIS-50/50	2" dia. x 1/4"	50/50	300 MW/cm ² *

*20 ns pulses, 10 Hz

Material	BK7 glass
Dimensions	
Diameter	+0,-0.1 mm
Thickness	±0.1 mm
Parallel	3-5'
Optical	
Flatness	1/20 wave
Polish, both sides	10/5

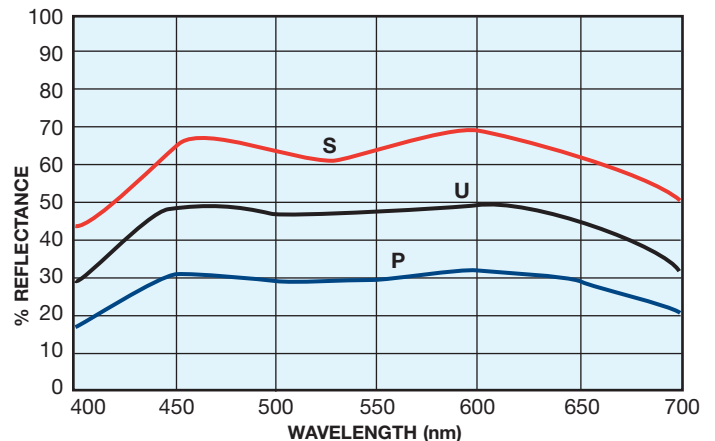
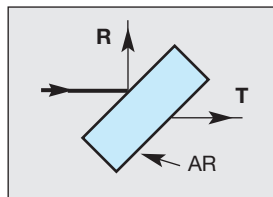

Dielectric Reflectors and Beamsplitters

OFR manufactures WINDOWS (see page OC- 34) to be coated for Max-R Mirrors, Output Couplers and Beamsplitters.

MAX-R Laser Line Mirrors, 0°

1" dia. X 1/4" Wavelength (nm) Catalog Number	2" dia. X 1/4" Wavelength (nm) Catalog Number	Reflectance	Bandwidth*	Power Rating**	Laser
MX-25-266	MX-51-266	99.5%	6-8%	300 MW/cm ²	Nd:YAG
MX-25-351	MX-51-351	99.5%	6-8%	300 MW/cm ²	XeF
MX-25-355	MX-51-355	99.5%	6-8%	300 MW/cm ²	Nd:YAG
MX-25-488	MX-51-488	99.8%	10%	500 MW/cm ²	Ar
MX-25-514	MX-51-514	99.8%	10%	500 MW/cm ²	Ar
MX-25-532	MX-51-532	99.8%	10%	500 MW/cm ²	Nd:YAG
MX-25-633	MX-51-633	99.8%	10%	500 MW/cm ²	HeNe
MX-25-780	MX-51-780	99.8%	10%	500 MW/cm ²	Diode
MX-25-810	MX-51-810	99.8%	10%	500 MW/cm ²	Diode
MX-25-830	MX-51-830	99.8%	10%	500 MW/cm ²	Diode
MX-25-850	MX-51-850	99.8%	10%	500 MW/cm ²	Diode
MX-25-980	MX-51-980	99.8%	10%	500 MW/cm ²	Diode
MX-25-1053	MX-51-1053	99.8%	10%	500 MW/cm ²	Nd:YLF
MX-25-1064	MX-51-1064	99.8%	10%	500 MW/cm ²	Nd:YAG
MX-25-1310	MX-51-1310	99.8%	10%	500 MW/cm ²	Diode
MX-25-1319	MX-51-1319	99.8%	10%	500 MW/cm ²	Diode
MX-25-1540	MX-51-1540	99.8%	10%	500 MW/cm ²	Diode

*Bandwidth shown is at ± 5% of peak. **Power Rating based on 20 n-sec pulses, 20 Hz,

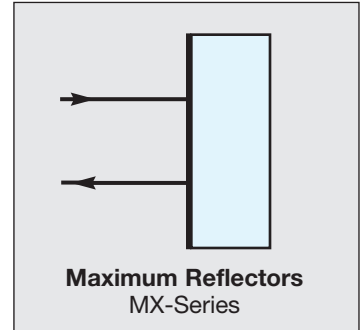

Wavelength	Substrate
UV	UV fused silica
VIS-NIR-IR	BK7
High power	Fused silica

Mechanical Specifications

Diameter	+0, -0.1 mm
Thickness	±0.1 mm
Parallel	1-3'

Optical Specifications

Flatness	1/20-wave
Polish, both sides	10%

MAX-R Laser Line Mirrors, 45°

1" dia. X 1/4" Wavelength (nm) Catalog Number	2" dia. X 1/4" Wavelength (nm) Catalog Number	Reflectance	Bandwidth*	Power Rating**	Laser
MY-25-193	MY-51-193	95%	3-4%	300 MW/cm ²	ArF
MY-25-212	MY-51-212	96%	3-4%	300 MW/cm ²	Nd:YAG
MY-25-248	MY-51-248	99%	3-4%	300 MW/cm ²	KrF
MY-25-266	MY-51-266	99.5%	3-4%	300 MW/cm ²	Nd:YAG
MY-25-325	MY-51-325	99.5%	6-8%	300 MW/cm ²	HeCd
MY-25-351	MY-51-351	99.5%	6-8%	300 MW/cm ²	XeF
MY-25-355	MY-51-355	99.5%	6-8%	300 MW/cm ²	Nd:YAG
MY-25-488	MY-51-488	99.8%	10%	500 MW/cm ²	Ar
MY-25-514	MY-51-514	99.8%	10%	500 MW/cm ²	Ar
MY-25-532	MY-51-532	99.8%	10%	500 MW/cm ²	Nd:YAG
MY-25-633	MY-51-633	99.8%	10%	500 MW/cm ²	HeNe
MY-25-650	MY-51-650	99.8%	10%	500 MW/cm ²	Diode
MY-25-670	MY-51-670	99.8%	10%	500 MW/cm ²	Diode
MY-25-780	MY-51-780	99.8%	10%	500 MW/cm ²	Diode
MY-25-810	MY-51-810	99.8%	10%	500 MW/cm ²	Diode
MY-25-830	MY-51-830	99.8%	10%	500 MW/cm ²	Diode
MY-25-850	MY-51-850	99.8%	10%	500 MW/cm ²	Diode
MY-25-980	MY-51-980	99.8%	10%	500 MW/cm ²	Diode
MY-25-1053	MY-51-1053	99.8%	10%	500 MW/cm ²	Nd:YLF
MY-25-1064	MY-51-1064	99.8%	10%	500 MW/cm ²	Nd:YAG
MY-25-1310	MY-51-1310	99.8%	10%	500 MW/cm ²	Diode
MY-25-1319	MY-51-1319	99.8%	10%	500 MW/cm ²	Diode
MY-25-1540	MY-51-1540	99.8%	10%	500 MW/cm ²	Diode
MY-25-2010	MY-51-2010	99.8%	10%	500 MW/cm ²	Tm:YAG
MY-25-2100	MY-51-2100	99.8%	10%	500 MW/cm ²	Ho:YAG

*Bandwidth shown is at ± 5% of peak. **Power Rating based on 20 n-sec pulses, 20 Hz,

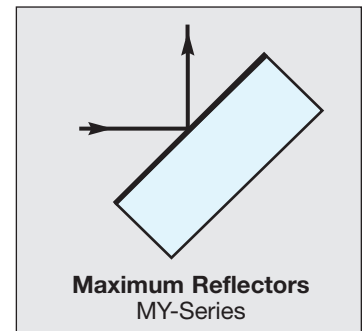

Wavelength	Substrate
UV	UV fused silica
VIS-NIR-IR	BK7
High power	Fused silica

Mechanical Specifications

Diameter	+0, -0.1 mm
Thickness	±0.1 mm
Parallel	1-3'

Optical Specifications

Flatness	1/20-wave
Polish, both sides	10%

Partial Reflectors and Beamsplitters

Partial Reflectors & Output Couplers, 0°

1" dia. X 1/4" Wavelength (nm) Catalog Number	2" dia. X 1/4" Wavelength (nm) Catalog Number	Bandwidth*	Power Rating**	Laser
MT-25-266-R/T	MT-51-266-R/T	10%	300 MW/cm ²	Nd:YAG
MT-25-351-R/T	MT-51-351-R/T	10%	300 MW/cm ²	XeF
MT-25-355-R/T	MT-51-355-R/T	10%	300 MW/cm ²	Nd:YAG
MT-25-488-R/T	MT-51-488-R/T	10%	500 MW/cm ²	Ar
MT-25-514-R/T	MT-51-514-R/T	10%	500 MW/cm ²	Ar
MT-25-532-R/T	MT-51-532-R/T	10%	500 MW/cm ²	Nd:YAG
MT-25-633-R/T	MT-51-633-R/T	10%	500 MW/cm ²	HeNe
MT-25-780-R/T	MT-51-780-R/T	10%	500 MW/cm ²	Diode
MT-25-810-R/T	MT-51-810-R/T	10%	500 MW/cm ²	Diode
MT-25-830-R/T	MT-51-830-R/T	10%	500 MW/cm ²	Diode
MT-25-850-R/T	MT-51-850-R/T	10%	500 MW/cm ²	Diode
MT-25-980-R/T	MT-51-980-R/T	10%	500 MW/cm ²	Diode
MT-25-1053-R/T	MT-51-1053-R/T	10%	500 MW/cm ²	Nd:YLF
MT-25-1064-R/T	MT-51-1064-R/T	10%	500 MW/cm ²	Nd:YAG
MT-25-1310-R/T	MT-51-1310-R/T	10%	500 MW/cm ²	Diode
MT-25-1319-R/T	MT-51-1319-R/T	10%	500 MW/cm ²	Diode
MT-25-1540-R/T	MT-51-1540-R/T	10%	500 MW/cm ²	Diode

*Bandwidth shown is at ± 5% of peak. **Power Rating based on 20 n-sec pulses, 20 Hz,

Wavelength	Substrate
UV	UV fused silica
VIS-NIR-IR	BK7
High power	Fused silica

Mechanical Specifications	
Diameter	+0, -0.1 mm
Thickness	±0.1 mm
Parallel	1-3'

Optical Specifications	
Flatness	1/20-wave
Polish, both sides	10%

To specify Split Ratios when ordering		
R/T		For example
04/96±1%		MT-25-1064-04/96
30/70±5%		MT-25-1064-30/70
40/60±5%		MT-25-1064-40/60
50/50±5%		MT-25-1064-50/50
60/40±5%		MT-25-1064-60/40
90/10±3%		MT-25-1064-90/10

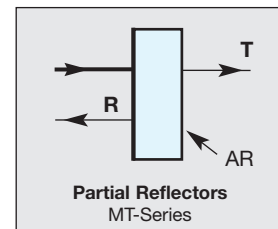

Beamsplitters, 45°

1" dia. X 1/4" Wavelength (nm) Catalog Number	2" dia. X 1/4" Wavelength (nm) Catalog Number	Bandwidth*	Power Rating**	Laser
MS-25-193-R/T-pol	MS-51-193-R/T-pol	10%	300 MW/cm ²	ArF
MS-25-212-R/T-pol	MS-51-212-R/T-pol	10%	300 MW/cm ²	Nd:YAG
MS-25-248-R/T-pol	MS-51-248-R/T-pol	10%	300 MW/cm ²	KrF
MS-25-266-R/T-pol	MS-51-266-R/T-pol	10%	300 MW/cm ²	Nd:YAG
MS-25-325-R/T-pol	MS-51-325-R/T-pol	10%	300 MW/cm ²	HeCd
MS-25-351-R/T-pol	MS-51-351-R/T-pol	10%	300 MW/cm ²	XeF
MS-25-355-R/T-pol	MS-51-355-R/T-pol	10%	300 MW/cm ²	Nd:YAG
MS-25-488-R/T-pol	MS-51-488-R/T-pol	10%	500 MW/cm ²	Ar
MS-25-514-R/T-pol	MS-51-514-R/T-pol	10%	500 MW/cm ²	Ar
MS-25-532-R/T-pol	MS-51-532-R/T-pol	10%	500 MW/cm ²	Nd:YAG
MS-25-633-R/T-pol	MS-51-633-R/T-pol	10%	500 MW/cm ²	HeNe
MS-25-650-R/T-pol	MS-51-650-R/T-pol	10%	500 MW/cm ²	Diode
MS-25-670-R/T-pol	MS-51-670-R/T-pol	10%	500 MW/cm ²	Diode
MS-25-780-R/T-pol	MS-51-780-R/T-pol	10%	500 MW/cm ²	Diode
MS-25-810-R/T-pol	MS-51-810-R/T-pol	10%	500 MW/cm ²	Diode
MS-25-830-R/T-pol	MS-51-830-R/T-pol	10%	500 MW/cm ²	Diode
MS-25-850-R/T-pol	MS-51-850-R/T-pol	10%	500 MW/cm ²	Diode
MS-25-980-R/T-pol	MS-51-980-R/T-pol	10%	500 MW/cm ²	Diode
MS-25-1053-R/T-pol	MS-51-1053-R/T-pol	10%	500 MW/cm ²	Nd:YLF
MS-25-1064-R/T-pol	MS-51-1064-R/T-pol	10%	500 MW/cm ²	Nd:YAG
MS-25-1310-R/T-pol	MS-51-1310-R/T-pol	10%	500 MW/cm ²	Diode
MS-25-1319-R/T-pol	MS-51-1319-R/T-pol	10%	500 MW/cm ²	Diode
MS-25-1540-R/T-pol	MS-51-1540-R/T-pol	10%	500 MW/cm ²	Diode
MS-25-2010-R/T-pol	MS-51-2010-R/T-pol	10%	500 MW/cm ²	Ti:YAG
MS-25-2100-R/T-pol	MS-51-2100-R/T-pol	10%	500 MW/cm ²	Ho:YAG

*Bandwidth shown is at ± 5% of peak. **Power Rating based on 20 n-sec pulses, 20 Hz,

Wavelength	Substrate
UV	UV fused silica
VIS-NIR-IR	BK7
High power	Fused silica

Mechanical Specifications	
Diameter	+0, -0.1 mm
Thickness	±0.1 mm
Parallel	1-3'

Optical Specifications	
Flatness	1/20-wave
Polish, both sides	10%

To Specify Split Ratios when ordering		
R/T	Polarization	For example
04/96±1%	U, S or P	MS-25-1064-04/96-S
30/70±5%	U, S or P	MS-25-1064-30/70-U
40/60±5%	U, S or P	MS-25-1064-40/60-P
50/50±5%	U, S or P	MS-25-1064-50/50-U
60/40±5%	U, S or P	MS-25-1064-60/40-S
90/10±3%	U, S or P	MS-25-1064-90/10-P

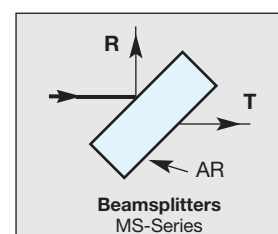

Beamsplitters

OFR manufactures and stocks standard Beamsplitter plates and prism cubes. As in all of our products, we will specially manufacture on a custom basis to customer's specifications.

BANDWIDTH OR TRANSMITTANCE, which is more important?

Metallic Coatings

Metallic coatings are achromatic over an extremely wide spectral range. For example, our beamsplitters are designed for equal reflection and transmission when used with unpolarized light at 45°. However, when used with S-polarized light, the R/T ratio is approximately 60/40, and with P-polarized, it is approximately 40/60.

Absorption in the metallic coating is $\frac{1}{3}$, and it is seen that if reflection equals transmission, then $R=T=33\%$.

Our standard metallic coating is vacuum-deposited inconel which forms a tough and relatively scratch-resistant film. It is recognized by its grey and neutral appearance, which is a sure sign of its achromaticity.

	Catalog Number	Coating	Application
PLATES	SU-Series	Metallic	General Purpose
PRISM CUBES	SCL-Series	All-Dielectric	Laser/Interferometer

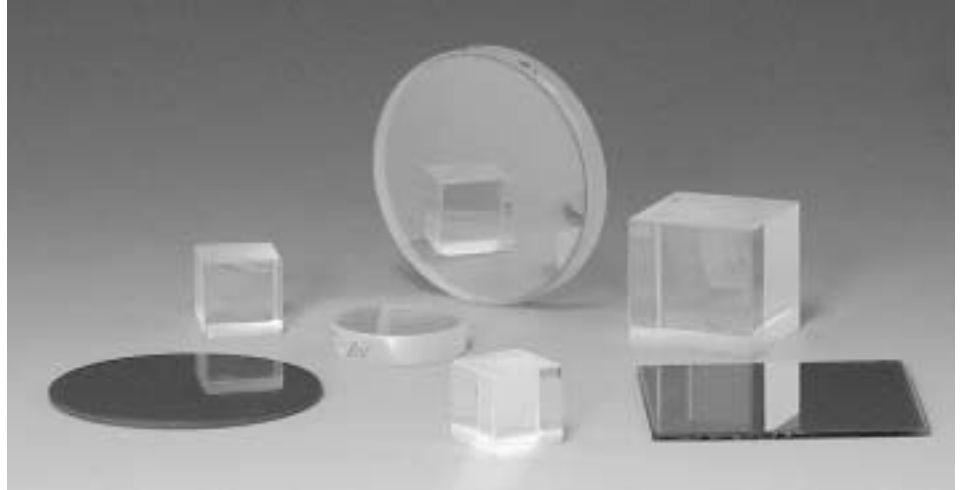

Dielectric Coatings

In general, dielectric coated beamsplitters have a narrower bandwidth than the metallic type, and are inherently of negligible absorption loss.

In general, dielectric coatings show much more effect upon the R/T ratio of polarized light than do metallic types.

Our standard beamsplitters are designed for equal reflectance/transmittance split when used with unpolarized light. However, when used with S-polarized light, the R/T ratio is 70/30, and with P-polarized the split is 30/70.

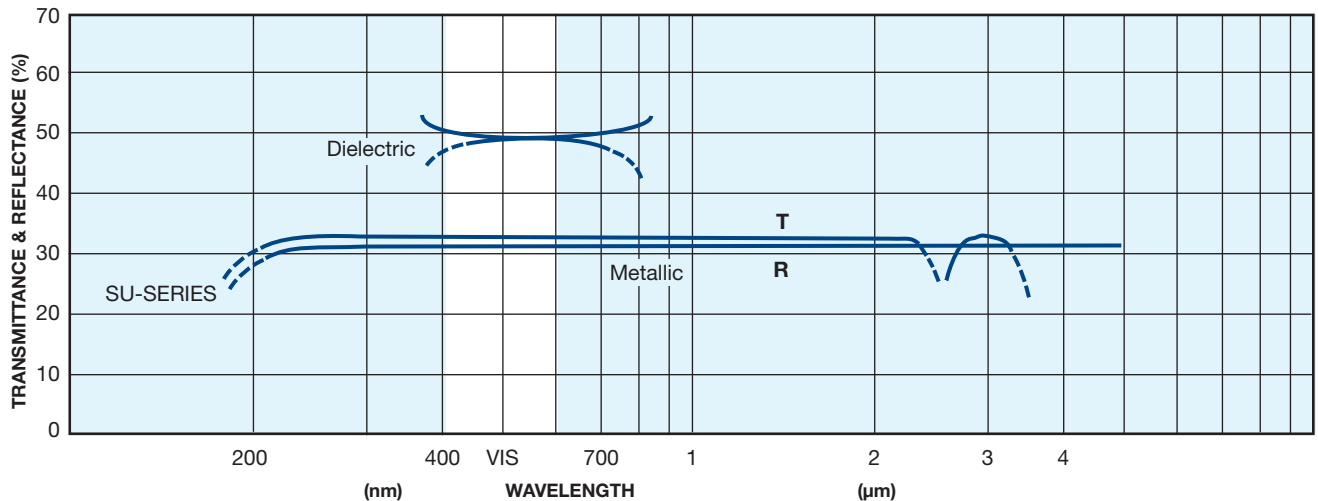

Beamsplitters

Beamsplitter Plates

OFR manufactures GENERAL-PURPOSE BEAMSPLITTER PLATES for applications where critical imaging or wavefront requirements are not stringent. For laser and interferometric applications requiring the highest specifications, see our DIELECTRIC BEAMSPLITTERS, page OC-16.



GENERAL-PURPOSE BEAMSPLITTER PLATES

Being thin, these Beamsplitter Plates are not sufficiently rigid to maintain flatness in all applications, and therefore are not intended for interferometry or applications requiring diffraction-limited performance.

Catalog Number	Achromatic Range	Unpolarized Split (R/T)	S-Polarized Split (R/T)	P-Polarized Split (R/T)	Dimensions	Material	Coating Type
SU-13	200 nm - 2.5 μm	"50/50" (33/33)	60/40	40/60	0.5" dia. x $\frac{1}{16}$ "	UV Silica	Metallic
SU-25	200 nm - 2.5 μm	"50/50" (33/33)	60/40	40/60	1" dia. x $\frac{1}{16}$ "	UV Silica	Metallic
SU-51	200 nm - 2.5 μm	"50/50" (33/33)	60/40	40/60	2" dia. x $\frac{1}{16}$ "	UV Silica	Metallic

General Purpose Beamsplitters: Schematic

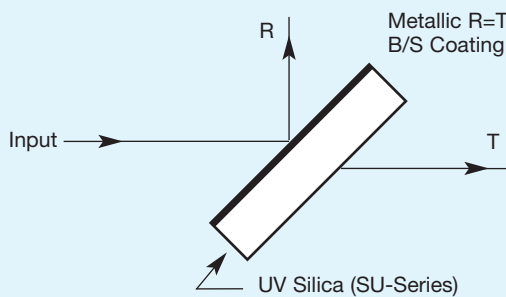

General Purpose Beamsplitters: Dimensions (mm)

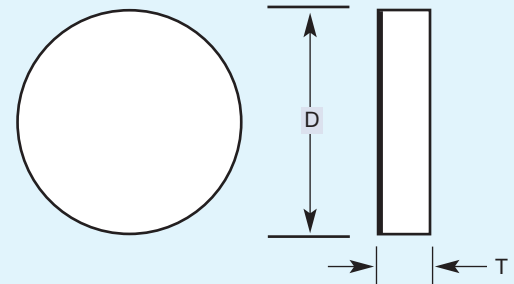

Series	Diameter	Thickness	Bevels
SU-13	12.7	1.5	0.1-0.3
SU-25	12.4	1.5	0.1-0.3
SU-51	50.8	1.5	0.1-0.3

Beamsplitters Prism Cubes

Beamsplitter Prism Cubes

OFR manufactures Prism Cube Beamsplitters using our AD-series Prisms (BK7 glass) with appropriate coatings. See page OC-30.

For ordering information on our Prism Mounting Platform, See page OC-30.

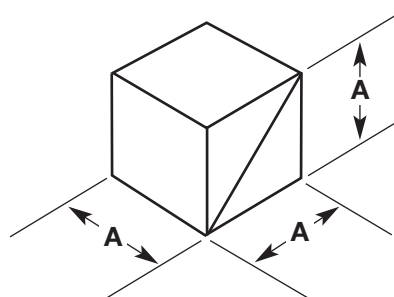
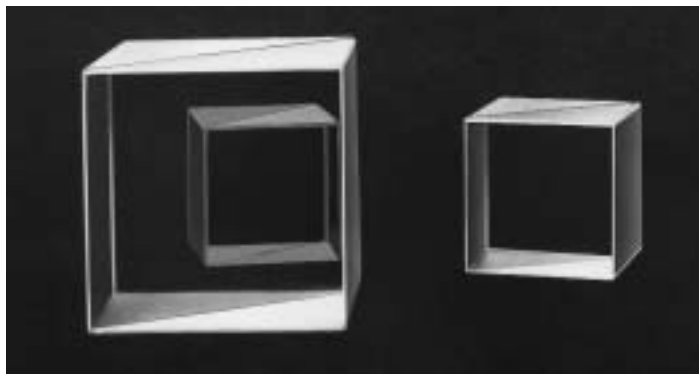

Part Number	A (mm)	All Faces
SCL-15	15.0 ± 0.1	1/10 -wave
SCL-25	25.4 ± 0.1	1/10 -wave

The four outer surfaces are coated with our Broadband Multilayer Antireflection Coating with per surface reflectance of 0.5%. The interface between the prisms is a dielectric, achromatic beamsplitter coating which produces a 50/50 split ± 5% across the visible spectrum when used with unpolarized light. With P-polarized light the ratio of R/T is 30/70, and with S-polarized, 70/30, approximately.

With grade A glass and all dielectric coatings, the insertion loss is negligible. However, because the Prisms are cemented together, use with high-power lasers which may burn the cement should be avoided.

For our POLARIZING BEAMSPLITTERS, please see page OC-24.

Catalog Number	Spectral Range	Split	Size	Material
SCL-15-VIS	450 - 650 nm	achromatic	15 mm cube	BK7
SCL-25-VIS	450 - 650 nm	achromatic	1"cube	BK7
SCL-15-VIR	550 - 780 nm	achromatic	15 mm cube	BK7
SCL-25-VIR	550 - 780 nm	achromatic	1"cube	BK7
SCL-15-NIR	750 - 950 nm	achromatic	15 mm cube	BK7
SCL-15-IR	1250 - 1550 nm	achromatic	15 mm cube	BK7

For our POLARIZING BEAMSPLITTERS, please see page OC-24, or below.

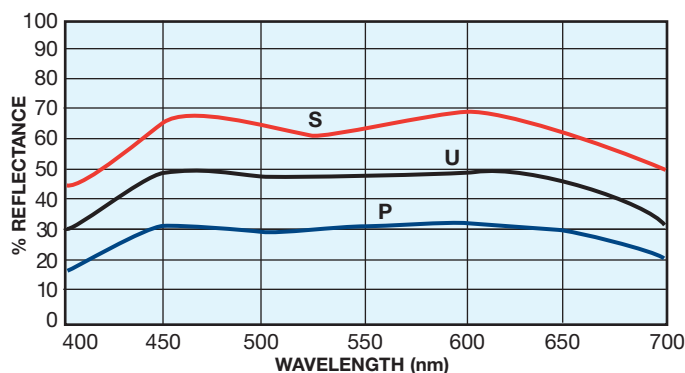

Polarizing Beamsplitters (See also Polarizing-State-Preserving Beamsplitter, next page)

Our prism-cube Polarizing Beamsplitters consist of our AD-Series right-angle prisms (see page OC-30) cemented together with dielectric coatings on all surfaces.

Because these are cemented, they cannot be used with high-energy lasers which may damage the cemented interface.

The p-polarized component is transmitted and the s-polarized is reflected at 90°. Extinction ratio of the transmitted p-component and reflected s-component is >2000:1.

See also page OC-24.

These broadband Polarizers cover the following spectral ranges.

Spectrum	Order as
435-650 nm	VIS
630-860 nm	VNIR
960-1064 nm	YAG
1310-1550 nm	IR

NOTE: When ordering, specify wavelength, PSCL-13-NIR for example.

Catalog Number	Transmittance p-component	Reflectance p-component	Reflectance s-component	Dimensions
PSCL-4-λ	>96%	<1.5%	>98%	4.0 mm ³
PSCL-13-λ	>96%	<1.5%	>98%	12.7 mm ³

Polarization-State-Preserving Beamsplitters

Broadband PSP* Beamsplitters *Polarization-State-Preserving

The state of polarization (SOP) of a beam of light can be described in terms of its S and P components, and the phase angle between them. In many beamsplitter applications, it is desirable that there be no change in the SOP between the input and the output beams. However, it is a natural phenomenon that the SOP of the input beam will be modified at the beam-splitting boundary, for non-normal incidence.

Various attempts to preserve the SOP have been made, for example "non-polarizing" beamsplitters. However, because of limitations of traditional coating techniques, these merely maintain the S and P amplitudes but not the phase angle between them. In addition, they are characterized by narrow bandwidths and fields-of-view.

THE OFR PSP BEAMSPLITTER utilizes unique and proprietary technology. It is the only beamsplitter on the market that

preserves the SOP of the input beam, and is characterized by wide bandwidths (50-100 nm) and wide fields-of-view ($\geq 5^\circ$). The PSP Beamsplitter produces a 50/50 split within 3% for both output beams, and preserves the SOP and phase angle of the polarized components of the input.

BEAMSLITTERS AND SOP

Fresnel's reflection coefficients describe the state of polarization (SOP) of reflected light in terms of the intensities of its S and P components. When the angle of incidence is non-perpendicular, the SOP of the reflected light will be different from that of the incident light.

The descriptions of the two resultant split beams are derived from equations that relate the angle of incidence at the boundary surface and the indices of refraction of the incident and transmission media. See formulas on the second side of the front cover of this section.

For fiber-optic applications, see page FO-13 in FIBER-OPTIC PRODUCTS section.

SPECIFICATIONS

- $R_s = T_s = 50\% \pm 3\%$
- $R_p = T_p = 50\% \pm 3\%$
- Bandwidth: $\lambda_c \pm 50 - 100 \text{ nm}$
- Power: $>400\text{MW}/\text{cm}^2$

Custom ratios available

Center (λ_c) Wavelength	Order as
500 nm	VIS
633 nm	VIR
800 nm	NIR1
980 nm	NIR2
1310 nm	IR1
1550 nm	IR2

NOTE: some wavelengths under development, please inquire.

ORDERING INFORMATION

Catalog Number	Aperture
PSP-5- λ	5 mm

λ : when ordering, specify wavelength, for example PSP-5-IR2.

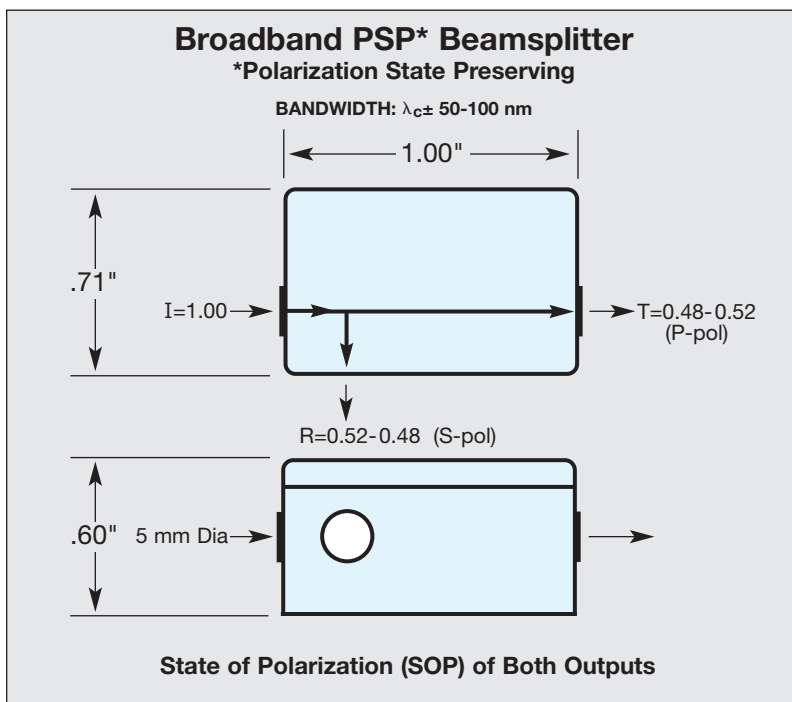

UV Polarizers

UV Polarizers (ROCHON, LOW POWER ONLY)

We manufacture the classical Rochon Polarizers in crystal quartz and MgF₂. Low power only! Damage threshold is complex. Please Inquire.

SPECIAL NOTICE

Significant power limitations must be observed with PVR and PUR models. Do not use with unexpanded laser beams, as power density (beam cross-sectional

area) can cause decontacting of polarizer prisms. Subject is complex, please inquire or request bulletin "Deep UV Polarization".

See **High Power UV Polarizers** below.

SPECIAL NOTICE

Polarized input beams can only be used with PVR polarizers.

Unpolarized input beams can be used with either PVR or PUR Polarizers.



N,T option Cell

W option Cell

CHARACTERISTICS

<input type="checkbox"/> Extinction ratios	1 x 10 ⁴ or better
<input type="checkbox"/> Transmittance	85-91%
<input type="checkbox"/> Surface flatness	better than 1/10-wave
<input type="checkbox"/> Transmitted wavefront	better than 1/4-wave
<input type="checkbox"/> Surface polish	better than 1%

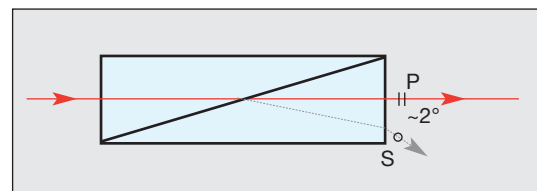

Catalog Number	Colinearity of P-Ray	Aperture	Wavelength	Separation of P from S	Material	Cell Dimensions
PVR-10-2-N	~5 min	10 mm	157*, 193 nm	2° (193 nm)	MgF ₂	1" dia. x 2"
PVR-10-2-T	~1 min	10 mm	157*, 193 nm	2° (193 nm)	MgF ₂	1" dia. x 2 1/2"
PVR-10-2-W	~10 sec	10 mm	157*, 193 nm	2° (193 nm)	MgF ₂	1" dia. x 2 1/2"
PUR-10-2-N	~5 min	10 mm	190 - 400 nm	2.5° (193 nm)	Quartz	1" dia. x 2"
PUR-10-2-T	~1 min	10 mm	190 - 400 nm	2.5° (193 nm)	Quartz	1" dia. x 2 1/2"
PUR-10-2-W	~10 sec	10 mm	190 - 400 nm	2.5° (193 nm)	Quartz	1" dia. x 2 1/2"

NOTES: (1) 157 nm is still experimental; (2) All models: Laser power limitations. Request bulletin "Deep UV Polarization". AR coatings available on special request.

High Power UV Polarizers

CHARACTERISTICS

<input type="checkbox"/> P-Pol output beam	parallel to input beam within 10 minutes.
<input type="checkbox"/> Extinction ratios	better than 10 ⁵ .
<input type="checkbox"/> Transmittance	>95% without AR coatings (incident beam at ~Brewster's Angle).
<input type="checkbox"/> Surface flatness	better than 1/10 wave.
<input type="checkbox"/> Transmitted wavefront	better than 1/4 wave full aperture.
<input type="checkbox"/> Surface polish	better than 1% wave.

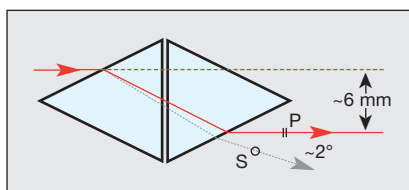

Air-spaced PSU, PSV-10

The subject of power limitation is complex. Please inquire.



Air-spaced PSV, PSU are mounted on H-A-51X platform for post mounting. See page OC-30.

Catalog Number	Aperture	Optimum Laser λ	Design Spectrum	Separation of P from S	Material	Compensating Prism	Off-Set
PSV-10-2-λ	10 mm	157* - 193 nm	150 - 200 nm	~2 °	MgF ₂	CaF ₂	~6 mm
PSU-10-2-λ	10 mm	193 - 355 nm	150 - 400 nm	~2.5°	Quartz	UV Quartz	~6 mm

*157 nm is still experimental. Please inquire.
λ: specify wavelength in nm when ordering.

High-Transmittance Laser Polarizers

Medium Power

SPECIFICATIONS

λ Order as	Spectrum	Power Rating*	Transmittance of P-Ray
VIS	450 - 675 nm	25 MW/cm ²	≥98%
VNIR	620 - 860 nm	25 MW/cm ²	≥98%
NIR	700 - 950 nm	25 MW/cm ²	≥98%
IR	1250 - 1550 nm	25 MW/cm ²	≥98%

*20 n-s pulses, 20 Hz.

Catalog Number	Aperture	Extinction
PE-6- λ	6 mm	≥5x10 ⁵
PE-8- λ	8 mm	≥5x10 ⁵
PE-10- λ	10 mm	≥5x10 ⁵

When ordering, specify wavelength, for example PE-10-VIS.

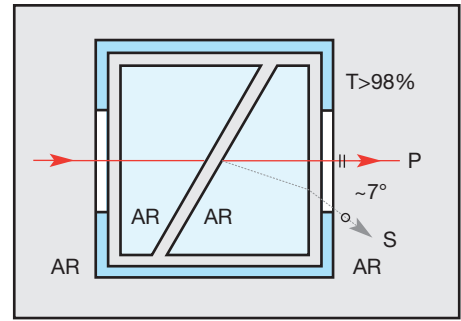

Air-spaced calcite design

Surface flatness	<1/10-wave
Transmitted wavefront	<1/4-wave
Surface polish	<20/10

High Power

SPECIFICATIONS

λ Order as	Spectrum	Power Rating*	Transmittance of P-Ray
NUV	350 - 500 nm	100 MW/cm ²	≥90%
VIS	450 - 650 nm	100 MW/cm ²	≥90%
VIR	500 - 750 nm	100 MW/cm ²	≥95%
NIR	700 - 900 nm	100 MW/cm ²	≥97%
TIS2	780 - 980 nm	100 MW/cm ²	≥97%
YAG	1030 - 1100 nm	200 MW/cm ²	≥97%
IR	1250-1600 nm	100 MW/cm ²	≥97%

*20 n-s pulses, 20 Hz.

Catalog Number	Aperture	Extinction
PEH-6- λ	6 mm	≥5x10 ⁵
PEH-8- λ	8 mm	≥5x10 ⁵
PEH-10- λ	10 mm	≥5x10 ⁵

When ordering, specify wavelength, for example PEH-10-YAG. *20 n-s pulses, 20 Hz.



Cell has escape windows on both sides.

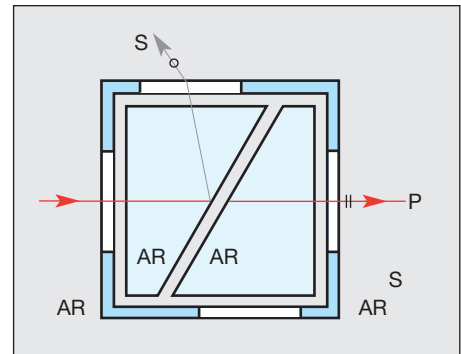

Air-spaced calcite design

Surface flatness	<1/10-wave
Transmitted wavefront	<1/4-wave
Surface polish	<20/10

Very High Power

Catalog Number	Aperture	Power Rating*	Transmittance		Cell Dimensions	
			of P-Ray	Extinction	Diameter	Length
PQ-5- λ	5 mm	500 MW/cm ²	≥ 95%	≥5x10 ⁵	1.00"	1.44"
PQ-7- λ	7 mm	500 MW/cm ²	≥ 95%	≥5x10 ⁵	1.00"	2.10"
PQ-10- λ	10 mm	500 MW/cm ²	≥ 95%	≥5x10 ⁵	1.12"	2.49"
PQ-12- λ	12 mm	500 MW/cm ²	≥ 95%	≥5x10 ⁵	1.37"	2.80"
PQ-15- λ	15 mm	500 MW/cm ²	≥ 95%	≥5x10 ⁵	1.37"	3.23"

*20 n-s pulses, 20 Hz

λ : When ordering, specify wavelength, for example PQ-15-1053.

Surface Flatness	<1/10-wave
Transmitted wavefront	<1/10-wave
Surface Polish	<10%

Standard Wavelength		
488 nm	532 nm	633 nm
1053 nm	1064 nm	

NOTE: UV λ 's under development, please inquire.

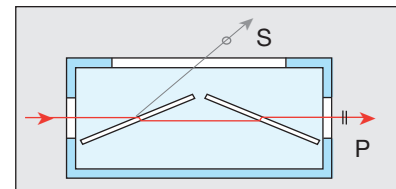

Chevron design, double plate Brewster's Angle Plates, dielectric coated, low deviation <10 seconds.



Polarizing Beamsplitters, Broadband, High Extinction

Our prism-cube Polarizing Beamsplitters consist of our AD-Series right-angle prisms (see page OC-30) cemented together with dielectric coatings on all surfaces. **Because these are cemented, they cannot be used with high-energy lasers which may damage the cemented interface.**

The p-polarized component is transmitted and the s-polarized is reflected at 90°. Extinction ratio of the transmitted p-component and reflected s-component is >2000:1.

These broadband Polarizers cover the following spectral ranges.

Spectrum	Order as
450-650 nm	VIS
630-860 nm	VNIR
960-1070 nm	YAG
1310-1550 nm	IR

NOTE: When ordering, specify wavelength, PSCL-13-NIR for example.

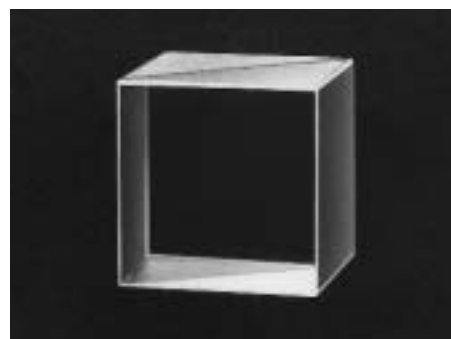

Catalog Number	Transmittance p-component	Reflectance p-component	Reflectance s-component	Dimensions
PSCL-4-λ	>96%	<1.5%	>98%	4.0 mm ³
PSCL-13-λ	>96%	<1.5%	>98%	12.7 mm ³

General-Purpose Polarizers

These are polarizing-film type Polarizers sandwiched between protective cover plates: UV grade fused silica for the UV series, and grade A glass for the visible and infrared series.

Our 15 mm series are mounted in our standard black-anodized cell, 1" dia x 0.3" thick. A white line scribed on the diameter of one face of the cell indicates the polarizing axis of the plate.

2" series are available as the cemented sandwich, or optionally mounted in our H-51-64 Cell.

These can only be used with low power lasers.

These cannot be used with high power lasers or in proximity with heat sources such as xenon or other lamps.

Catalog Number	Aperture	Spectrum	Cover Plate	Transmittance	Extinction
PUM-15	15 mm dia.	275 - 500 nm	UV Silica	20%	1000:1
PUM-51	2" dia.	275 - 500 nm	UV Silica	20%	1000:1
PM-15	15 mm dia.	400 - 700 nm	Glass	40%	10,000:1
PM-51	2" dia.	400 - 700 nm	Glass	40%	10,000:1
H-51-64	Cell for PUM/PM-51 2½" diameter x ½" thick.				



PUM/PM-15 are mounted in 1" diameter Cell. PUM/PM-51 are unmounted, or optionally in H-51-64 Cell.

Walk-Off Polarizers

Walk-Off Polarizers are especially useful in fiber-optic applications to separate light of varying State of Polarization (SOP) into its S and P polarized components. These precision polished calcite blocks internally separate an input beam into the two polarized beams by 6° 14', yielding a 1:10 ratio of separation-to-length at output. It is possible to double the separation by putting two units in series.

To maintain complete separation at output of the S and P beams, do not exceed Maximum Beam Diameter at input.

Walk-Off Polarizers are available uncoated, or optionally with AR on both faces. Specify λ when ordering

For applications requiring larger beams or greater separation, contact OFR.

Catalog Number	Maximum* Beam Dia.	HxWxL Dimensions	Separation of S and P at Output	Tp & Ts	Extinction
PB-0.6-0.6-λ	0.6 mm.	4x4x6.3 mm	0.6 mm	≥99%	>60dB
PB-1.0-1.0-λ	1.0 mm.	3x5x10 mm	1.0 mm	≥99%	>60dB

λ: for optional AR coatings, specify wavelength in nm.

* Note: output beams will overlap if Maximum Beam Diameter is exceeded.

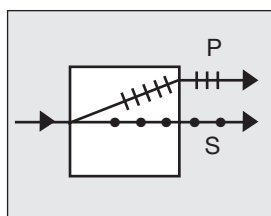

IR Polarizers

Infrared Polarizers

MID-RANGE IR POLARIZER, 2.5-4 μm

Our Mid-IR Polarizer is analogous to the airspaced calcite polarizers (pages OC-24) except that it utilizes IR transmitting TiO₂ (rutile). For high-power laser applications, we will specially fabricate the Polarizer with side rejection windows. Please inquire.

Catalog Number	Aperture	Transmittance	Power Rating	Extinction	Field-of View	Cell* Dimension
PT-8	8 mm dia.	$\geq 94\%$	10 W cw	5×10^5	$\pm 1^\circ$	1" dia x 1" long

*Same cell as PE-Series, page OC-23.

PLEASE NOTE: For infrared laser diode operating in the 1.5 μm region, see page OC-23, PE-X-IR.

CO₂ LASER POLARIZER, 10.6 μm

Our unique design utilizes ZnSe plates at Brewster's Angle. The standard unit is optimized for 10.6 μm .

Catalog Number	Aperture	Power Rating	Extinction	Transmittance	Cell Dimensions	
					Diameter	Length
PHB-7	7 mm	1 kW cw	$\geq 3000:1$	$\geq 94\%$	2.49"	1.12"
PHB-9	9 mm	1 kW cw	$\geq 3000:1$	$\geq 94\%$	2.80"	1.37"
PHB-11	11 mm	1 kW cw	$\geq 3000:1$	$\geq 94\%$	3.23"	1.37"

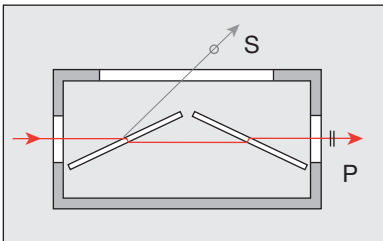

Depolarizers

These double crystal quartz wedges are so oriented as to cause a "depolarization" of polarized light, which is to say that if our Depolarizer is situated between a Polarizer and a rotating Analyzer, the resulting light transmitted through the Analyzer will not vary in intensity.

One type of depolarizer, the Lyot, does not have a "fast" or preferred axis. However, it is not entirely achromatic, and has wavelength periodicity in its depolarized spectrum.

Another type is the wedge depolarizer. It is achromatic, but has a preferred axis, meaning that this axis must be oriented at 45° with respect to the plane of polarization, thus making it unusable in applications wherein the plane of polarization varies in attitude.

The OFR Depolarizer is a proprietary design. It is achromatic throughout its

operating spectrum with no wavelength periodicity. Further, it does not possess a fast or preferred axis, so that it is effective in varying polarization applications. Being optically contacted, these can be used in the UV.

Performance is optimized with expanded beams, >6 mm diameter. Power rating is ~10W/cm².

The DPU-15 is mounted in our standard retarder cell (see photo). The DPU-25 is not mounted. Antireflection coatings are optional.

ANTIREFLECTION COATINGS

Spectrum	Order as
325-500 nm	NUV
450-650 nm	VIS
700-900 nm	NIR
980-1660 nm	YAG
1310-1550 nm	IR

NOTE: When ordering, specify wavelength, DPU-25-NIR for example.

Catalog Number	Aperture	Spectrum
DPU-15	15 mm dia.	190 nm-2.5 μm
DPU-25	1" dia.	190 nm-2.5 μm



DPU-15, mounted in cell.
DPU-25, is not mounted

Laser Retarders (Waveplates)

We fabricate these from selected natural and synthetic crystalline quartz, and other crystals depending upon wavelength.

All of our quartz Retarders are multi-layer antireflection coated on both sides so that transmittance exceeds 99% at the design wavelength. Precision of retardation is guaranteed to be within ¼% of design value. Transmitted wavefront is better than ¼₁₀-wave across the full aperture.

We calibrate every Retarder which is shipped out. We will furnish upon request, and at no additional charge, the calibrated value of any plate.

Aperture is 15 mm in 1" cell with scribed line indicating slow axis. Surface quality 10/5 or better, flatness better than 1/20 wave, parallel better than 2 seconds.



MULTIPLE-ORDER RETARDERS, Crystalline quartz

This is the single plate Retarder, and is no more nor less accurate than the zero order type under ordinary laboratory conditions. They will display more sensitivity to temperature change than the zero-order type. These Retardation Plates are precision polished to achieve the desired retardation at the desired wavelength. Aperture is 15 mm.

The high dispersion of refraction index at shorter wavelengths narrows both

angular aperture and bandwidth. Thus, we limit our multiple-order Retarders to 400 nm and longer wavelengths. For UV excimer lasers, we recommend our more tolerant zero-order Retarders (see next page).

Both sides are AR coated.

We manufacture Retarders from 3.6 µm to 7.0 µm on a custom basis in MgF₂ crystal. Please inquire.

Change in phase retardation ($\Delta\phi$) relates to bandwidth, field of view and temperature change, using a 1 mm thick plate. Temperature stability describes the change in phase retardation per °C of temperature change.

Material	Crystal quartz
Retardance	±½%
Parallel	1 second

Quarter-wave

Catalog Number & Wavelegth	Bandwidth	Field of View	Temperature Stability ($\Delta\phi/^\circ\text{C}$)
RM-¼-488	±0.1 nm	±1.0°	0.020
RM-¼-514	±0.1 nm	±1.0°	0.019
RM-¼-633	±0.1 nm	±1.0°	0.018
RM-¼-780	±0.2 nm	±1.2°	0.018
RM-¼-980	±0.3 nm	±1.4°	0.017
RM-¼-1053	±0.4 nm	±1.5°	0.017
RM-¼-1064	±0.4 nm	±1.5°	0.016
RM-¼-1310	±0.5 nm	±1.6°	0.016
RM-¼-1480	±0.7 nm	±1.8°	0.015
RM-¼-1550	±0.7 nm	±1.8°	0.015
RM-¼-1560	±0.7 nm	±1.8°	0.015

*Value assumes a tolerable phase retardation error of 1%

MANY MORE WAVELENGTHS IN STOCK. IF NOT, WE'LL MAKE IT.

Half-wave

Catalog Number & Wavelegth	Bandwidth	Field of View	Temperature Stability ($\Delta\phi/^\circ\text{C}$)
RM-½-488	±0.1 nm	±1.3°	0.019
RM-½-514	±0.2 nm	±1.4°	0.019
RM-½-633	±0.2 nm	±1.6°	0.018
RM-½-780	±0.4 nm	±1.8°	0.018
RM-½-980	±0.6 nm	±2.0°	0.017
RM-½-1053	±0.7 nm	±2.1°	0.017
RM-½-1064	±0.7 nm	±2.1°	0.016
RM-½-1310	±1.0 nm	±2.3°	0.016
RM-½-1480	±1.3 nm	±2.4°	0.015
RM-½-1550	±1.7 nm	±2.7°	0.015
RM-½-1560	±1.7 nm	±2.7°	0.014

*Value assumes a tolerable phase retardation error of 1%

MANY MORE WAVELENGTHS IN STOCK. IF NOT, WE'LL MAKE IT.

Laser Retarders

ZERO-ORDER RETARDERS, Crystalline quartz

These are air-spaced, double plate Retarders. All surfaces are AR coated. These are no more nor less accurate than the multiple-order type under ordinary laboratory conditions. However, these have

wider bandwidth and less sensitivity to temperature change than the multiple-order type. These Retardation Plates are within the "zeroeth" order of retardance, that is between $(0\lambda-1\lambda)$.

Material	Crystal quartz
Retardance	$\pm 1/2\%$
Parallel	2 seconds

Quarter-wave

Catalog Number & Wavele ^g th	Bandwidth	Field of View	Temperature Stability ($\Delta\phi/^\circ\text{C}$)
RZ-1/4-193	± 1.9 nm	$\pm 0.4^\circ$	0.00013
RZ-1/4-213	± 2.1 nm	$\pm 0.5^\circ$	0.00014
RZ-1/4-248	± 2.5 nm	$\pm 0.6^\circ$	0.00018
RZ-1/4-266	± 2.6 nm	$\pm 0.6^\circ$	0.00022
RZ-1/4-308	± 3.1 nm	$\pm 0.6^\circ$	0.00026
RZ-1/4-325	± 3.2 nm	$\pm 0.7^\circ$	0.00029
RZ-1/4-351	± 3.5 nm	$\pm 0.7^\circ$	0.00029
RZ-1/4-442	± 4.4 nm	$\pm 0.8^\circ$	0.00029
RZ-1/4-488	± 4.8 nm	$\pm 0.8^\circ$	0.00029
RZ-1/4-514	± 5.1 nm	$\pm 0.9^\circ$	0.00029
RZ-1/4-532	± 5.3 nm	$\pm 0.9^\circ$	0.00030
RZ-1/4-633	± 6.3 nm	$\pm 1.0^\circ$	0.00030
RZ-1/4-670	± 6.6 nm	$\pm 1.0^\circ$	0.00030
RZ-1/4-780	± 7.7 nm	$\pm 1.1^\circ$	0.00031
RZ-1/4-830	± 8.2 nm	$\pm 1.1^\circ$	0.00031
RZ-1/4-852	± 8.4 nm	$\pm 1.1^\circ$	0.00031
RZ-1/4-980	± 9.7 nm	$\pm 1.2^\circ$	0.00032
RZ-1/4-1053	± 10.4 nm	$\pm 1.3^\circ$	0.00032
RZ-1/4-1064	± 10.5 nm	$\pm 1.3^\circ$	0.00032
RZ-1/4-1310	± 13.0 nm	$\pm 1.5^\circ$	0.00033
RZ-1/4-1480	± 14.7 nm	$\pm 1.6^\circ$	0.00033
RZ-1/4-1550	± 15.4 nm	$\pm 1.6^\circ$	0.00034
RZ-1/4-1560	± 15.4 nm	$\pm 1.6^\circ$	0.00034

*Value assumes a tolerable phase retardation error of 1%
MANY MORE WAVELENGTHS IN STOCK. IF NOT, WE'LL MAKE IT.

Half-wave

Catalog Number & Wavele ^g th	Bandwidth	Field of View	Temperature Stability ($\Delta\phi/^\circ\text{C}$)
RZ-1/2-193	± 1.9 nm	$\pm 0.6^\circ$	0.00028
RZ-1/2-213	± 2.1 nm	$\pm 0.7^\circ$	0.00029
RZ-1/2-248	± 2.5 nm	$\pm 0.8^\circ$	0.00034
RZ-1/2-266	± 2.6 nm	$\pm 0.8^\circ$	0.00042
RZ-1/2-308	± 3.1 nm	$\pm 0.9^\circ$	0.00051
RZ-1/2-325	± 3.2 nm	$\pm 0.9^\circ$	0.00058
RZ-1/2-351	± 3.5 nm	$\pm 1.0^\circ$	0.00058
RZ-1/2-442	± 4.4 nm	$\pm 1.1^\circ$	0.00059
RZ-1/2-488	± 4.8 nm	$\pm 1.2^\circ$	0.00060
RZ-1/2-514	± 5.1 nm	$\pm 1.2^\circ$	0.00061
RZ-1/2-532	± 5.3 nm	$\pm 1.3^\circ$	0.00062
RZ-1/2-633	± 6.3 nm	$\pm 1.4^\circ$	0.00062
RZ-1/2-670	± 6.6 nm	$\pm 1.4^\circ$	0.00062
RZ-1/2-780	± 7.7 nm	$\pm 1.6^\circ$	0.00062
RZ-1/2-830	± 8.2 nm	$\pm 1.6^\circ$	0.00063
RZ-1/2-852	± 8.4 nm	$\pm 1.7^\circ$	0.00063
RZ-1/2-980	± 9.7 nm	$\pm 1.8^\circ$	0.00063
RZ-1/2-1053	± 10.4 nm	$\pm 1.8^\circ$	0.00064
RZ-1/2-1064	± 10.5 nm	$\pm 1.9^\circ$	0.00064
RZ-1/2-1310	± 13.0 nm	$\pm 2.1^\circ$	0.00064
RZ-1/2-1480	± 14.7 nm	$\pm 2.2^\circ$	0.00065
RZ-1/2-1550	± 15.4 nm	$\pm 2.3^\circ$	0.00065
RZ-1/2-1560	± 15.4 nm	$\pm 2.3^\circ$	0.00065

*Value assumes a tolerable phase retardation error of 1%
MANY MORE WAVELENGTHS IN STOCK. IF NOT, WE'LL MAKE IT.

BROADBAND 1/2-WAVE RETARDERS FOR POLARIZATION ROTATION

A 1/2-wave retarder will rotate the plane of polarization by an amount that is twice the angle between the retarder axis (the white scribed line on the Cell) and the polarization plane.

This Retarder is a combination of birefringent crystal plates, resulting in broadband phase retardation accurate within 1% across the designated spectrum.

With broadband AR coatings, these Retarders transmit >98%. Mounted in standard Cell.

Aperture is 15 mm.

Catalog Number	Wavele ^g th	Field of View	Temperature Stability
RMA-1/2-NIR1	600-950 nm	$>\pm 2^\circ$	<0.1 nm/ $^\circ\text{C}$
RMA-1/2-NIR2	780-1170 nm	$>\pm 2^\circ$	<0.1 nm/ $^\circ\text{C}$
RMA-1/2-IR	1250-1560 nm	$>\pm 2^\circ$	<0.1 nm/ $^\circ\text{C}$

*Value assumes a tolerable phase retardation error of 1%



Material	Crystal quartz + MgF ₂
Retardance	$\pm 1/2\%$
Parallel	2 seconds

Retarders

MICA RETARDERS

OFR manufactures and stocks 1/2-wave and 1/4-wave Retarders in common laser wavelengths, cemented between protective glass cover plates. We do not AR coat mica Retarders, as internal transmittance is ~85%. However, mica Retarders are very

high quality plates, with uniform retardance across the aperture, and wavefront distortion < 1/4-wave. Because of the natural absorptance of mica, insertion losses become quite high with increasing wavelength (the plate becomes thicker).

Thus, for practicality, we do not recommend mica retarders beyond ~850 nm.

Mica Retarders are guaranteed to be accurate within 1% of peak value.

$\lambda/4$ -wave* Catalog Number	$\lambda/2$ -wave* Catalog Number	Wavelength	Bandwidth	Field of View	Temperature Stability
RA-1/4 488	RA-1/2-488	488 nm	± 6 nm	>±2°	<0.1 nm/°C
RA-1/4 514	RA-1/2-514	514 nm	± 6 nm	>±2°	<0.1 nm/°C
RA-1/4 633	RA-1/2-633	633 nm	± 6 nm	>±2°	<0.1 nm/°C
RA-1/4 670	RA-1/2-670	670 nm	± 6 nm	>±2°	<0.1 nm/°C
RA-1/4 780	RA-1/2-780	780 nm	± 6 nm	>±2°	<0.1 nm/°C

*Value assumes a tolerable phase retardation error of 1%

Material	Mica between glass
Retardance	±1%
Parallel	2 minutes

Broadband Retarders (Fresnel Rhombs)

FRESNEL RHOMBS

The most achromatic of all Retarders are the Fresnel Rhombs. We manufacture both 1/4-wave and 1/2-wave models for the ultra-violet and the visible-near IR. Surface quality 10/5 or better, flatness better than 1/10 wave, parallel better than 10 seconds.

MOUNTING CELLS are provided with the Fresnel Rhombs. Both cells have 1/4 -20 holes for standard bench post mounting.

The 1/2-Wave Retarders Mounting Cell also mounts into any 2" dia. mirror mount.

Function of a 1/4-wave retarder is to convert linearly polarized light, whose plane is at 45° to retarder axis, to circularly polarized.

Function of a 1/2-wave retarder is to rotate the plane of polarization. See BROADBAND 1/2-WAVE RETARDERS , page OC-27.

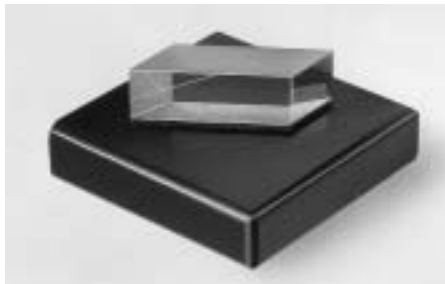

RF-1/4



RF-1/2

$\lambda/4$ -wave* Catalog Number	$\lambda/2$ -wave* Catalog Number	Wavelength	Field of View	Aperture	Material
RFU-1/4 UVB	RFU 1/2-UVB	240-360 nm	>±2°	10 mm	UV Silica
RFU-1/4 NUV	RFU 1/2-NUV	225-500 nm	>±2°	10 mm	UV Silica
RF-1/4 VIS	RF 1/2-VIS	425-675 nm	>±2°	10 mm	Glass
RF-1/4 VIR	RF 1/2-VIR	550-780 nm	>±2°	10 mm	Glass
RF-1/4 NIR	RF 1/2-NIB	700-950 nm	>±2°	10 mm	Glass
RF-1/4 IR	RF 1/2-IR	1250-1560 nm	>±2°	10 mm	Glass

*Value assumes a tolerable phase retardation error of 1%

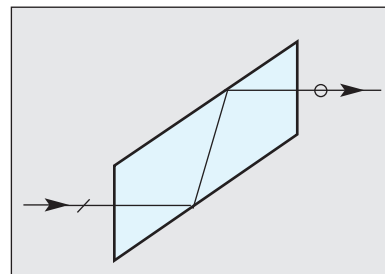

1/4 - Wave

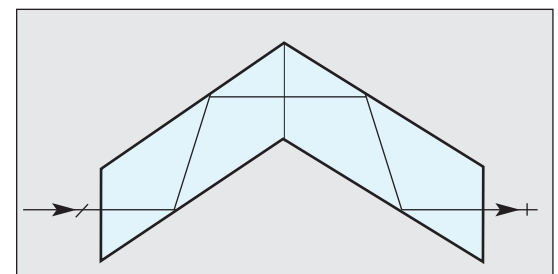

1/2 - Wave

Variable Retarders

Variable Retarders and Soleil-Babinet Compensator

Whereas the traditional application of the Soleil-Babinet Compensator is as an instrument for the analysis of polarized light, we have introduced its use as an adjustable retarder, with emphasis in the laser lab where many wavelengths are employed.

The heart of the OFR Variable Retarder and Soleil-Babinet Compensator is the set of crystal quartz wedges: a longer wedge moves with respect to a fixed shorter wedge. The combination of the wedges comprises a zero-order retarder which is adjustable from 0 to 2π of phase retardation at any wavelength from 190 nm to 1.0 μm . Operation at longer wavelengths is possible, however at less than 2π of phase retardation.

These instruments are useable with high-power lasers, and available upon request with antireflection coatings.

The fast axis of the Retarder is parallel to the long base of the instrument. In operation, the plane of polarization will normally be at $\pm 45^\circ$ with respect to this axis.

The S-B Compensator is actually a variable retarder that can be adjusted from 0 to 2π of phase retardation. When used as the Variable Retarder, a 2" diameter x $\frac{1}{2}$ " black-anodized aluminum plate is attached on the rear face of the instrument. This plate fits into any standard 2" mirror mount, which allows full rotation to correspond to any plane of polarization orientation.

For full capability as a classic Soleil-Babinet Compensator, the instrument is mounted onto the Divided Circle Rotator which allows full 360° of rotation, with locking at any angle therein, as well as 2-axis tilting. It has the additional feature of $\pm 45^\circ$ detents for ease of setting.

ELECTRONIC DIGITAL READOUT is a feature of the micrometer actuator. This, along with "zero reset" and memory, simplifies operation. An RS-232 Port can be accessed for data acquisition and processing. Resolution is 0.001 of the wavelength.

Catalog Number	Description	Aperture
RC-10	Variable Retarder	10 mm
SB-10	Soleil-Babinet Compensator	10 mm



RC-10 Variable Retarder

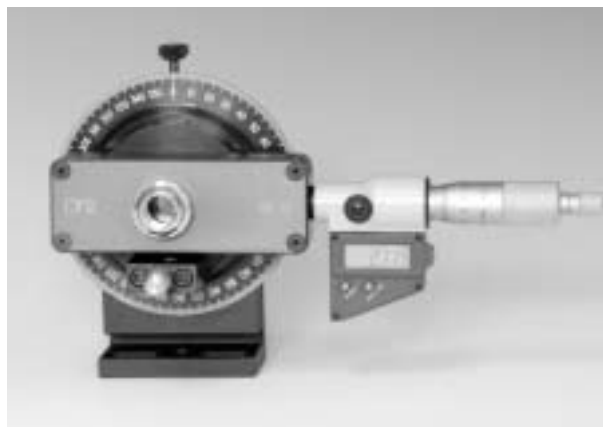

SB-10 Soleil-Babinet Compensator

Birefringent Filter Plates (Crystal Quartz)

We manufacture Birefringent Filter Plates in crystalline quartz to customer specifications. These are similar to our Retarders in that the crystal axis is parallel to the face of the plates.

Wavefront distortion of each plate is better than $\frac{1}{10}$ - $\frac{1}{20}$ wave, with parallelism of the faces better than 1 second of arc.

Birefringent Filters are used in dye laser tuning.

We manufacture Birefringent Filter Plates on a custom basis. Please check our inventory.

Prisms

OFR manufactures and stocks a wide variety of Prisms. In addition to our standard product line listed below, we will specially fabricate prisms to custom specifications.

We manufacture several standard Prisms in CaF₂ for use in the ultraviolet. Please Inquire.

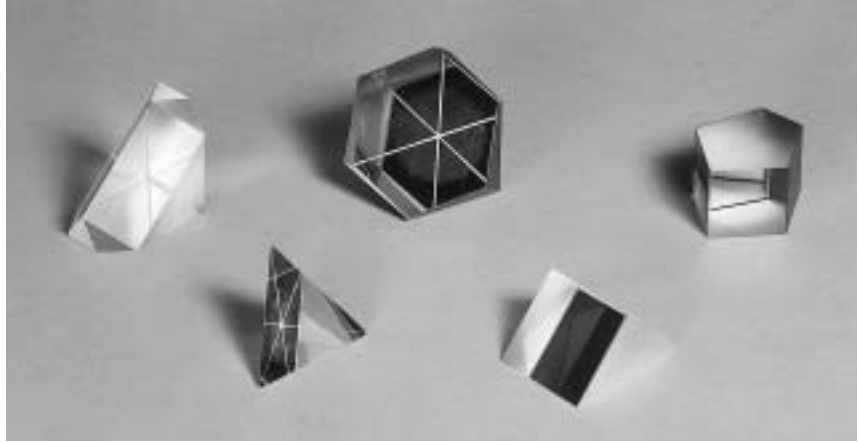

PRISM MOUNTING PLATFORM

This black-anodized plate, 2 x 2", 1/2" thick, has a 1/4-20 threaded hole for mounting on a standard optical bench-post, and is intended for convenient mounting of Prisms and Beamsplitter Prism Cubes.

In order to avoid possible strain which can be caused by clamping hardware, we prefer using a double-sided urethane-sponge tape (supplied) for prism mounting.



Catalog Number	Description
H-A-51X	Prism Mounting Platform

RIGHT ANGLE PRISMS

The 45-45-90 degree Prism is the most commonly purchased of all our Prisms, and has several applications: to produce 90° reflection of light, to retroreflect light (Porro Prism), and even as a front-surface mirror with the hypotenuse aluminized.

The surfaces of these Prisms are flat within 1/10-wave. Angles are within 3 minutes.

In addition, we select from our production those Prisms to be used as the two components in making our SCL-series Beamsplitter Cubes. Please see BEAMSPLITTERS, page OC-20.

Catalog Number	Square Aperture	Material	Transmission Spectrum
ADV-15	15 mm	CaF ₂	130 nm - 9.6 μm
ADV-25	1"	CaF ₂	130 nm - 9.6 μm
ADU-15	15 mm	UV Silica	190 nm - 2.5 μm
ADU-25	1"	UV Silica	190 nm - 2.5 μm
AD-15	15mm	Glass	380 nm - 2.5 μm
AD-25	1"	Glass	380 nm - 2.5 μm
AD-51	2"	Glass	380 nm - 2.5 μm

MECHANICAL SPECIFICATIONS

Dimensions	+0,-0.1 mm
Angles	±1-3 minutes
Surface Flatness	1/10-1/20 wave
Polish	10/5
Bevels	0.3 mm X 45°



Pellin-Broca Prisms (Brewster's Angle 90°)

We fabricate Pellin-Broca in CaF₂ for the vacuum-ultraviolet, and in UV-grade fused silica for the ultraviolet and near-infrared. These are designed so that the entrance and exit faces are approximately at Brewster's angle for the design spectrum, thus minimizing reflection losses for p-polarized light.

Catalog Number	Square Aperture	Material	Design Spectrum	Limit of Transmission	Separation $\lambda_2-\lambda_1^*$	Brewster's Angle
ADBV-10	10 mm	CaF ₂	130 nm-250 nm	9.6 μm	$\sim 3^\circ$	56°-59°
ADBV-20	20 mm	CaF ₂	130 nm-250 nm	9.6 μm	$\sim 3^\circ$	56°-59°
ADBU-10	10 mm	UV Silica	190 nm-425 nm	2.5 μm	$\sim 7^\circ$	56°-57°
ADBU-20	20 mm	UV Silica	190 nm-425 nm	2.5 μm	$\sim 7^\circ$	56°-57°
ADB-10	10 mm	BK7 Glass	380 nm-2.5 μm	2.5 μm	$\sim 2^\circ$	56°-57°
ADB-20	20 mm	BK7 Glass	380 nm-2.5 μm	2.5 μm	$\sim 2^\circ$	56°-57°

NOTE: deviation is complex; Please inquire.

* $\lambda_2-\lambda_1$ refers to Design Spectrum extremes, for example 130/250 nm (ADBV).

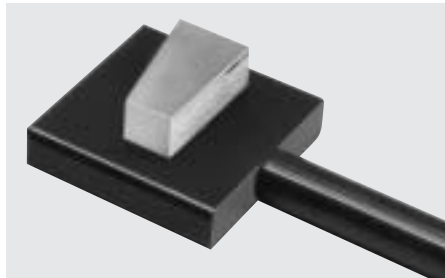
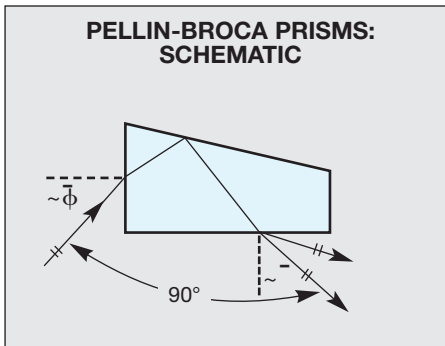

MECHANICAL SPECIFICATIONS

Dimensions	+0,-0.1 mm
Angles	$\pm 1-3$ minutes
Surface Flatness	1/10-1/20 wave
Polish	10/5
Bevels	0.3 mm X 45°

Dispersing Prisms (Brewster's Angle)

We fabricate Dispersing Prisms in CaF₂ for the vacuum-ultraviolet, in UV grade fused silica for the ultraviolet, and in high-dispersion glass for the visible and near-infrared. These are designed so that the entrance and exit faces are approximately at Brewster's angle for the design spectrum, thus minimizing reflection losses for p-polarized light.

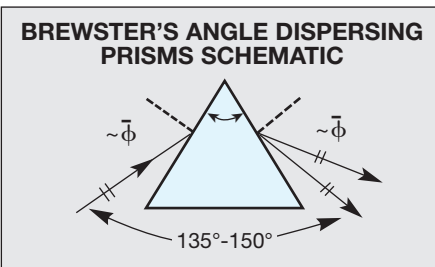

MECHANICAL SPECIFICATIONS

Dimensions	+0,-0.1 mm
Angles	$\pm 1-3$ minutes
Surface Flatness	1/10-1/20 wave
Polish	10/5
Bevels	0.3 mm X 45°

Catalog Number	Square Aperture	Material	Design Spectrum	Limit of Transmission	Separation $\lambda_2-\lambda_1^*$	Brewster's Angle	Apex Angle
ABSV-15	15 mm	CaF ₂	130 nm-250 nm	9.6 μm	$\sim 5^\circ$	56°-59°	69.9°
ABSV-25	1"	CaF ₂	130 nm-250 nm	9.6 μm	$\sim 5^\circ$	56°-59°	69.9°
ABSU-15	15 mm	UV Silica	190 nm-425 nm	2.5 μm	$\sim 12^\circ$	56°-57°	67.8°
ABSU-25	1"	UV Silica	190 nm-425 nm	2.5 μm	$\sim 12^\circ$	56°-57°	67.8°
ABS-15	15 mm	SF14 Glass	380 nm-2.5 μm	2.5 μm	$\sim 10^\circ$	56°-57°	60.0°
ABS-25	1"	SF14 Glass	380 nm-2.5 μm	2.5 μm	$\sim 10^\circ$	56°-57°	60.0°

NOTE: deviation is complex; Please inquire.

* $\lambda_2-\lambda_1$ refers to Design Spectrum extremes, for example 130/250 nm (ABSV).

Coupling Prisms (Rutile & GGG)

High index of refraction prisms are used for the coupling of light into films for the purpose of measuring film thickness and refractive index. We will gladly furnish a list of reference articles on the subject upon request.

For the measurement of films whose index is above 1.8, our rutile crystal (TiO_2) prisms are used. Extraordinary index is 2.865.

For films below index 1.8, we offer our prism in gadolinium gallium garnet (GGG), with index 1.965.

All three prism faces are polished to $\frac{1}{4}$ -wave flat, and the 90° corner is sharp (no bevel).

CAUTION: Prism coupling will cause scratching of the faces and chipping of the sharp edge.

Catalog Number	Angles	Dimensions	Material
ADT-6	45-45-90°	6 x 6 mm base	Rutile
AT-6	30-60-90°	6 x 6 mm base	Rutile
ADG-6	45-45-90°	6 x 6 mm base	GGG

PRISM COUPLER METHOD TO MEASURE THIN FILM THICKNESS AND REFRACTIVE INDEX

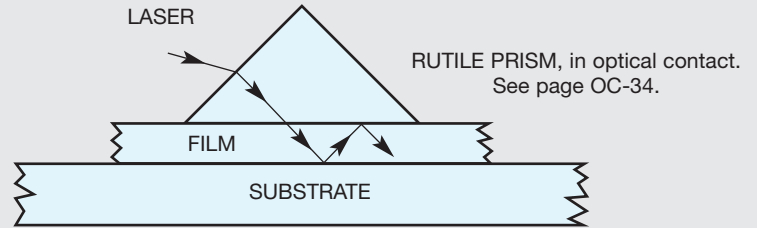

Indices of Refraction for OFR Coupling Prisms

Wavelength	GGG		RUTILE	
	T_e/T_m		$n_o(T_e)$	$n_e(T_m)$
488 nm	1.988		2.732	3.042
633 nm	1.965		2.584	2.865
830 nm	1.951		2.513	2.779
1064 nm	1.944		2.479	2.733
1550 nm	1.936		2.453	2.694

MECHANICAL SPECIFICATIONS

Dimensions	+0,-0.1 mm
Angles	± 1 -3 minutes
Surface Flatness	1/10-1/20 wave
Polish	10/5
Bevels	0.3 mm X 45°

RUTILE PRISMS

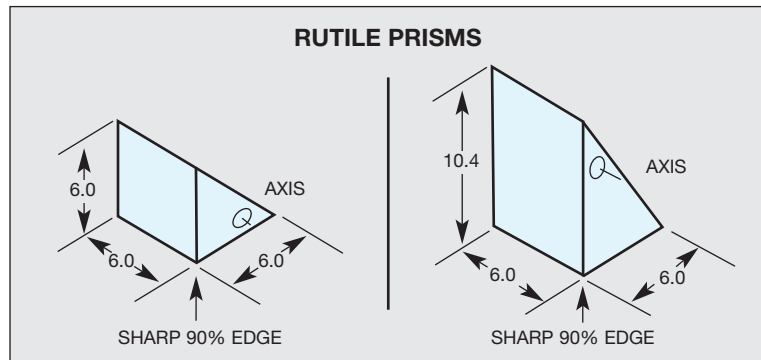

ADT-6, ADG-6 (no axis)

AT-6



Preparing boule of Rutile for fabrication into prisms.

Neutral Density Filters

Neutral Density Filters

OFR manufactures and stocks Neutral Density Filters in density steps from 0.1 to 3.0. These are neutral and accurate across their design range within 2-5% of absolute value.

The neutral density is achieved by a vacuum-deposited film of inconel metal. This is characterised by extreme achromaticity, however at the expense of absorption loss. Thus, these may possibly not be suitable for use with high-power lasers.

These are available individually or as a Boxed Set of Twelve Filters.

When requested, we will run a complete spectral transmittance graph of any purchased filter or filter set; please inquire.



Neutral Filters: Density vs Transmittance

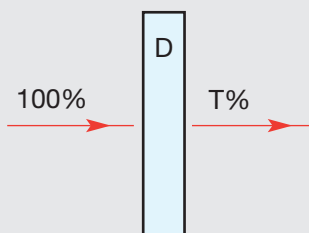

$$D = \log_{10}\left(\frac{1}{T}\right)$$

$$T = (\log^{-1}D)^{-1} = (10^D)^{-1}$$

ULTRAVIOLET NEUTRAL DENSITY FILTERS

These are in UV grade fused silica and designed for operation from 200-400 nm, although transmittance is to 2.5 μm .

Density & Catalog Number	Approximate Transmittance
FDU-0.1	0.79
FDU-0.2	0.63
FDU-0.3	0.50
FDU-0.4	0.40
FDU-0.5	0.32
FDU-0.6	0.25
FDU-0.7	0.20
FDU-0.8	0.16
FDU-0.9	0.13
FDU-1.0	0.10
FDU-2.0	0.01
FDU-3.0	0.001

Dimensions

2" dia. x $\frac{1}{16}$ "

Catalog Number: FD-Set Boxed Set of Twelve Filters

NEUTRAL DENSITY FILTERS

These are in glass and designed for operation in the visible spectrum, although neutral to 2.5 μm .

Density & Catalog Number	Approximate Transmittance
FD-0.1	0.79
FD-0.2	0.63
FD-0.3	0.50
FD-0.4	0.40
FD-0.5	0.32
FD-0.6	0.25
FD-0.7	0.20
FD-0.8	0.16
FD-0.9	0.13
FD-1.0	0.10
FD-2.0	0.01
FD-3.0	0.001

Dimensions

2" x 2" x $\frac{1}{16}$ "

Catalog Number: FD-Set Boxed Set of Twelve Filters

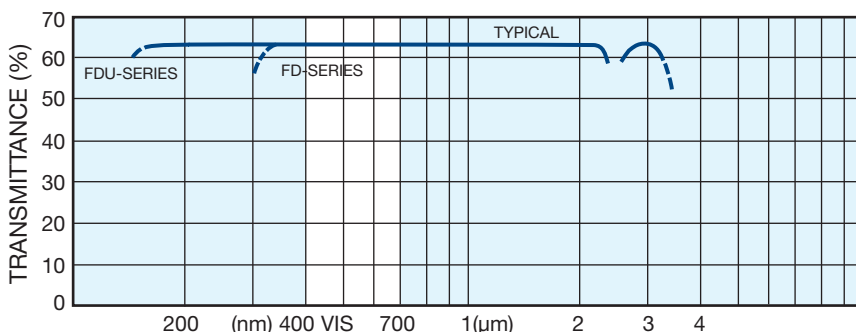

Windows

OFR manufactures and stocks Windows which we use as substrates for our Dielectric Coated Laser Components (see page OC-14).

MECHANICAL SPECIFICATIONS

Diameter:	+0-0.1 mm
Thickness:	± 0.1 mm
Parallelism:	1-3'
Bevel:	0.3mm x 45°

Catalog Number	Spectral Range	Material	Surface Flatness	Dimensions	Surface Polish
WV-25	130 nm - 9.6 μm	CaF ₂	1/20-wave	1" dia. x 1/4"	20/10
WV-51	130 nm - 9.6 μm	CaF ₂	1/20-wave	2" dia. x 1/4"	20/10
WU-25	190 nm - 2.5 μm	UV Silica	1/20-wave	1" dia. x 1/4"	10/5
WU-51	190 nm - 2.5 μm	UV Silica	1/20-wave	2" dia. x 1/4"	10/5
W-25	380 nm - 2.5 μm	BK7	1/20-wave	1" dia. x 1/4"	10/5
W-51	380 nm - 2.5 μm	BK7	1/20-wave	2" dia. x 1/4"	10/5
WQ-25	250 nm - 2.5 μm	Fused Silica	1/20-wave	1" dia. x 1/4"	10/5
WQ-51	250 nm - 2.5 μm	Fused Silica	1/20-wave	2" dia. x 1/4"	10/5

We will specially fabricate windows of all sizes and materials and specifications on a custom basis; please inquire.

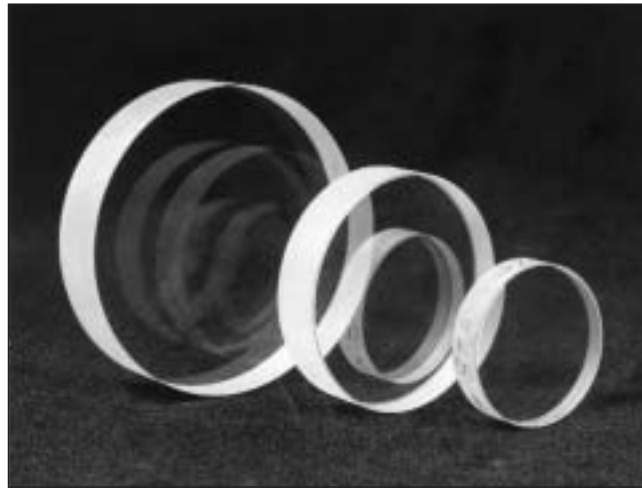

Optical Contacting

Optical contacting is a process by which two surfaces are adhered together through molecular attraction without the use of an adhesive.

It is a technique which is used in the precision optical shop when it is necessary to eliminate the dimensional uncertainty of wax or adhesive. For example, because optical parts are held down on the holding plate (block) usually by wax, it can be seen that the finite thickness of the wax not only can vary from piece to piece, but can also be wedged. When the specification calls for tight parallelism or angle tolerance, usually below one minute, the optician will employ optical contacting.

Another instance when optical contacting is utilized is when the specification requires a very tight tolerance on thickness, usually better than 0.02 mm.

In the above examples, the optician will use the "contact plate" which is usually of fused silica or other transparent, low expansion material, and whose thickness is known to a precision of better than 0.001 mm. The surfaces of this plate are extremely parallel, 1/2 arc-second or better, with both sides very flat, at least 1/20-wave.

The contacting process involves a technique of cleaning the contacting surface of this plate to an exceptionally high degree. The parts being manufactured have already been polished extremely flat on one side. This side is likewise cleaned. The optician then brings the two surfaces together, and this is where the optician's skill comes into action, and the two surfaces literally adhere. The parts are then "sealed" around the edges with shellac or lacquer to prevent the polishing

water from breaking the contact.

The optician then grinds and polishes the parts to specification, knowing that there is zero dimension between the parts and the contact plate.

Certain finished products are contacted. These will usually be used in high-power laser applications in which optical cement could be damaged, or at wavelengths where optical cement will not transmit, such as in the ultraviolet. Most optical cements are opaque below 325 nm, although one brand transmits to 250 nm.

Optical contacting is a skill, and as in any art, one becomes proficient only with long practice.

Solid Etalons

OFR manufactures Solid Etalons in fused silica which we will dielectrically coat as required. These 1" diameter plates are polished together as a 6" diameter cluster which is $\frac{1}{20}$ -wave flat (the finest we can resolve). Thus, we assume the surfaces of each plate to be much flatter than the cluster. Surfaces are parallel to ≤ 1 arc second.

Catalog Number	Thickness	Diameter	Reflectance Both Sides	Wavelength
IE-0.5	0.5 mm	1.0"	85-90%	500-700 nm
IE-1.0	1.0 mm	1.0"	85-90%	500-700 nm
IE-2.0	2.0 mm	1.0"	85-90%	500-700 nm
IE-5.0	5.0 mm	1.0"	85-90%	500-700 nm
IE-10.0	10.0 mm	1.0"	85-90%	500-700 nm

We will coat both sides for other wavelengths. Please inquire.

Notes on IR Materials

Optical materials transmitting in the infrared are generally much more costly than their visible spectrum counterparts. Furthermore, there are many IR transmitting materials whose properties are comparatively very different. Therefore, it is usually the application which determines the kind of material to be used, along with other factors such as cost, need for antireflection coatings, hygroscopicity, abrasion resistance, and other mechanical properties.

Throughout this catalog, we list many IR transmitting components which we generally stock as standards. However, we will specially manufacture most optical components as required in the following materials.

HYGROSCOPIC, LOW REFRACTIVE INDEX (AR COATINGS NOT NEEDED)

Material	Useful Spectrum	Comments	Comparative Cost
NaCl	UV-16 μm	IR lenses, windows, prisms	Moderate
KCl	UV-20 μm	IR lenses, windows, prisms	Moderate
KBr	UV-25 μm	IR lenses, windows, prisms	High
CsI	UV-50 μm	IR lenses, windows	High

NON-HYGROSCOPIC, LOW REFRACTIVE INDEX (AR COATINGS NOT NEEDED)

Material	Useful Spectrum	Comments	Comparative Cost
CaF ₂	VUV - 9.6 μm	IR lenses, windows, prisms	Moderate
BaF ₂ *	VUV - 11 μm	IR lenses, windows, prisms	Moderate
MgF ₂	VUV - 7 μm	Birefringent, Polarizing optics	High
LiF	VUV - 5 μm	VUV lenses, windows, prisms	High

*BaF₂ is not suitable for CO₂ laser applications.

NON-HYGROSCOPIC, HIGH REFRACTIVE INDEX (AR COATINGS NEEDED)

Material	Useful Spectrum	Comments	Comparative Cost
Sapphire	UV-6 μm	Used for mechanical properties	Very High
As ₂ S ₃	VIS-10 μm	General IR optics	Very High
Ge	2-20 μm	Mostly CO ₂ optics	Very High
Si	2-10 μm	General IR optics	Very High
KRS-5	VIS - 40 μm	Mechanically poor qualities	Very High
ZnS	VIS -11 μm	General IR optics, CO ₂ optics	Very High
ZnSe	VIS -16 μm	General IR optics, CO ₂ optics	Very High
GaAs	VIS-12 μm	General IR optics, CO ₂ optics	Very High
Ge-As-Se	VIS -12 μm	General IR optics	Very High